

brother®

1 KNOWING YOUR
SEWING MACHINE

2 STRAIGHT AND
ZIGZAG STITCHING

3 BUILT-IN STITCHES

4 SEWING BUTTONHOLES
AND BUTTONS

5 USING ATTACHMENTS
AND APPLICATIONS

6 APPENDIX

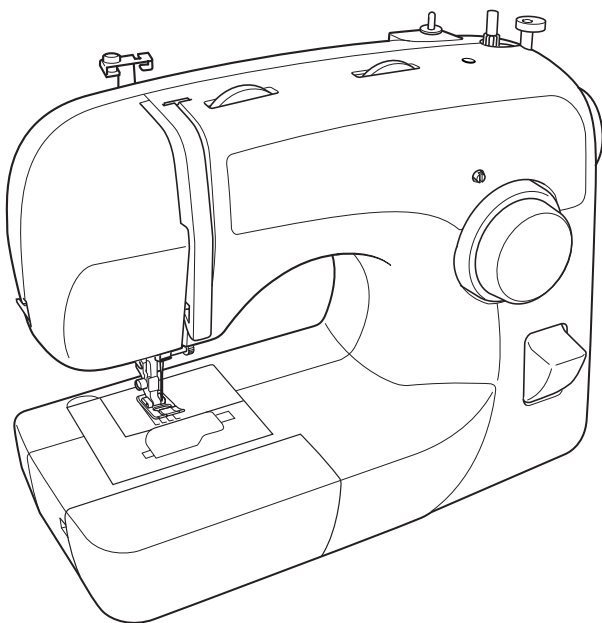

Operation Manual

IMPORTANT SAFETY INSTRUCTIONS

When using this machine, basic safety precautions should always be taken, including the following:

Read all instructions before using.

DANGER - To reduce the risk of electric shock:

1. The machine should never be left unattended while plugged in. Always unplug the machine from the electrical outlet immediately after using and before cleaning.
2. Always unplug the machine before you change the light bulb.
Replace the bulb with same type rated 15 watts.

WARNING - To reduce the risk of burns, fire, electric shock, or injury to persons:

1. Do not allow this machine to be used as a toy. Close attention is necessary when the machine is used by or near children.
2. Use this machine only for its intended use as described in this manual. Use only accessories recommended by the manufacturer as contained in this manual.
3. Never operate this machine if it has a damaged cord or plug, if it is not working properly, if it has been dropped or damaged, or dropped into water. Return the machine to the nearest authorized dealer or service center for examination, repair, electrical or mechanical adjustment.
4. Never operate the machine with any air openings blocked. Keep ventilation openings of the machine and foot control free from the accumulation of lint, dust, and loose cloth.
5. Never drop or insert any object into any opening.
6. Do not use outdoors.
7. Do not operate where aerosol (spray) products are being used or where oxygen is being administered.
8. To disconnect, turn the machine switch to the symbol "O" position which represents off, then remove plug from outlet.
9. Do not unplug by pulling on cord. To unplug, grasp the plug, not the cord.
10. Keep fingers away from all moving parts. Special care is required around the machine needle.
11. Always use the proper needle plate. The wrong plate can cause the needle to break.
12. Do not use bent needles.
13. Do not pull or push fabric while stitching. It may deflect the needle, causing it to break.
14. Switch the machine to the symbol "O" position to turn it off when making any adjustments in the needle area, such as threading needle, changing needle, threading bobbin, or changing presser foot, and the like.
15. Always unplug the machine from the electrical outlet when removing covers, lubricating, or when making any other user servicing adjustments mentioned in the instruction manual.
16. This sewing machine is not intended for use by young children or infirm persons without supervision. (For Australia and New Zealand only)
17. Young children should be supervised to ensure that they do not play with this machine.

SAVE THESE INSTRUCTIONS
This machine is intended for household use.

FOR USERS IN THE UK, EIRE, MALTA AND CYPRUS ONLY

If this machine is fitted with a three-pin non-rewireable BS plug then please read the following.

IMPORTANT

If the available socket outlet is not suitable for the plug supplied with this equipment, it should be cut off and an appropriate three pin plug fitted. With alternative plugs an approved fuse must be fitted in the plug.

NOTE: The plug severed from the main leads must be destroyed as a plug with bared flexible cords is hazardous if engaged in a live socket outlet. In the event of replacing the plug fuse, use a fuse approved by ASTA to BS 1362, i.e. carrying the  mark, rating as marked on plug.

Always replace the fuse cover. Never use plugs with the fuse cover omitted.

WARNING: DO NOT CONNECT EITHER WIRE TO THE EARTH TERMINAL WHICH IS MARKED WITH THE LETTER 'E', BY THE EARTH SYMBOL  OR COLOURED GREEN OR GREEN AND YELLOW.

The wires in this main lead are coloured in accordance with the following code:

Blue	Neutral
Brown	Live

As the colours of the wiring in the main lead of this appliance may not correspond with the coloured markings identifying the terminals in your plug, proceed as follows:

The wire which is coloured blue must be connected to the terminal which is marked with the letter 'N' or coloured black or blue.

The wire which is coloured brown must be connected to the terminal which is marked with the letter 'L' or coloured red or brown.

UNPACKING/REPACKING INSTRUCTIONS

Keep the carton and packing materials. You may have to take or send the machine to be repaired. If you do not pack it properly, or do not use the right packing material, the machine could be damaged. Please follow the diagram below to unpack and repack the machine.

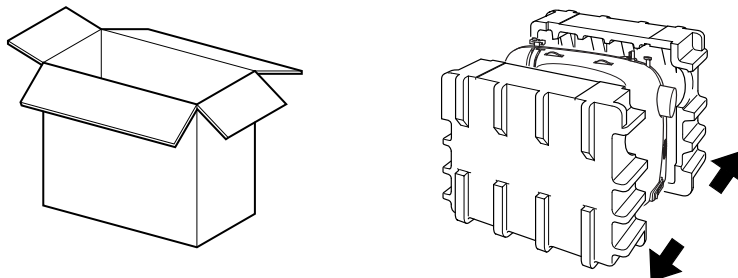

IMPORTANT

- This packing material is designed to prevent damage. Save this packing material if you need to take or send this machine to be repaired.

PLEASE READ THESE INSTRUCTIONS BEFORE YOU USE THE MACHINE.

To use the machine safely

1. Make sure you watch the needle carefully while you are sewing. Do not touch the handwheel, thread take-up lever, needle, or other moving parts.
2. Turn off the main power and unplug the cord in the following circumstances:
 - When you have stopped using the machine
 - When you are replacing or removing the needle or any other part
 - If there is a power failure while you are using the machine
 - If you are checking or cleaning the machine
 - Leaving the machine unattended
3. Do not store anything on the foot controller.
4. Plug the machine directly into the wall. Do not use extension cords.

To give your machine a longer life

1. Do not store this machine in direct sunlight or in high humidity conditions. Do not use or store the machine near a heater, iron, halogen lamp or other hot objects.
2. Use only mild soaps or detergents to clean the case. Benzene, thinner, and scouring powders can damage the case and machine, and should never be used.
3. Do not drop or hit the machine.
4. Always consult this manual before you replace or fit presser feet, the needle, or any other parts to make sure you fit them correctly.

To repair or adjust the machine

If the machine breaks down or needs adjustment, first follow the troubleshooting table in the Appendix to inspect and adjust the machine yourself. If the problem is still there, consult your local authorized dealer.

For additional product information and updates, visit our web site at www.brother.com.

The contents of this manual and specifications of this product are subject to change without notice.

CONTENTS

1. KNOWING YOUR SEWING MACHINE	5
THE MAIN PARTS	5
ACCESSORIES	6
Optional Accessories	6
USING YOUR SEWING MACHINE	7
Connecting Plugs	7
Main Power and Sewing Light Switch	8
Foot Controller	8
Checking the Needle	8
Replacing the Needle	8
Changing the Presser Foot	9
Flat Bed Attachment	10
Using a Free-arm Style	10
THE CONTROLS	11
Pattern Selection Dial	11
Patterns and Stitch Names	12
Stitch Length Dial	14
Stretch Stitching	15
Stitch Width Dial	15
Reverse Sewing Lever	15
THREADING THE MACHINE	16
Winding the Bobbin	16
Lower Threading	18
Lower Threading (for models equipped with a quick-set bobbin)	19
Upper Threading	21
Using the Needle Threader (for models equipped with a needle threader)	22
Drawing up the Lower Thread	24
Sewing with a Twin Needle	24
Thread Tension	25
FABRIC, THREAD, AND NEEDLE COMBINATIONS	26
2. STRAIGHT AND ZIGZAG STITCHING	27
Please Read Before Sewing	27
Straight Stitching	27
Zigzag Stitching	28
3. BUILT-IN STITCHES	29
Blind Hem Stitching	29
Shell Tuck Stitching	29
Elastic Stitching	30
Double Action Stitching	31
Heirloom Stitching	31
Overedge Stitching	31
Feather Stitching	32
Triple Zigzag Stretch Stitching	32
Decorative Stitching	33
4. SEWING BUTTONHOLES AND BUTTONS	34
Making a Buttonhole (1-Step Automatic Buttonhole)	34
Adjusting Buttonholes	35
Sewing Buttons	36

5. USING ATTACHMENTS AND APPLICATIONS37

Zipper Insertion 37
Gathering 38
Darning 38
Appliqués 39
Monogramming and Embroidering 39

OPTIONAL ACCESSORIES 41

Using the Walking Foot 41
Using the Quilting Foot 42
Using the 1/4-inch Quilting Foot 43

6. APPENDIX 44

MAINTENANCE 44

Changing the Light Bulb 44
Cleaning 44
Troubleshooting 46

INDEX 49

THE MAIN PARTS

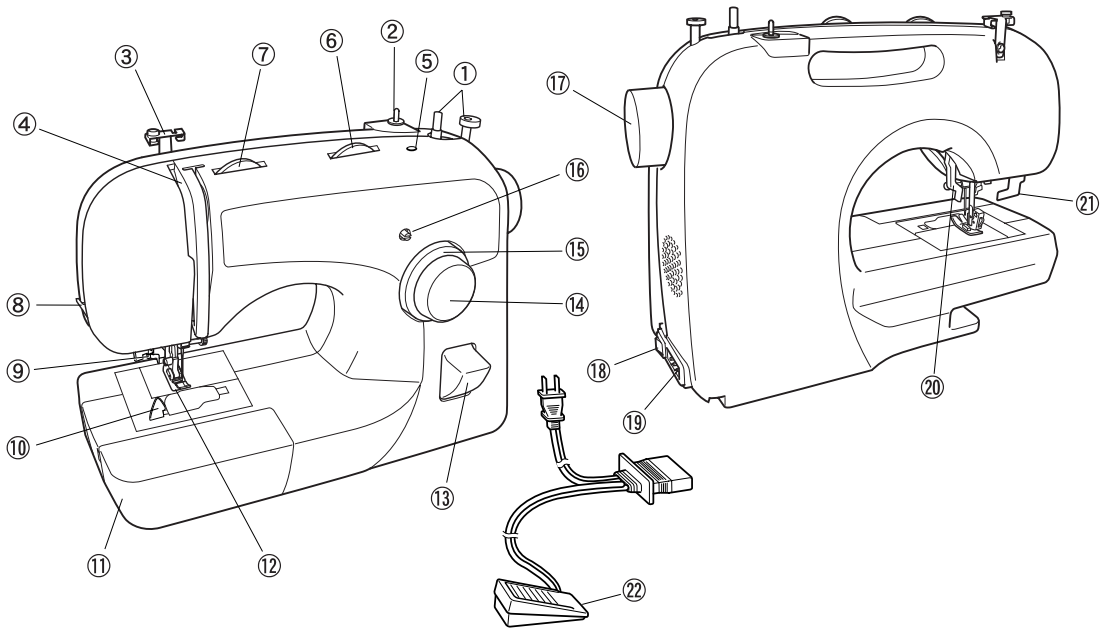

- ① **Bobbin winder (Page 16)**
This winds the thread onto the bobbin for use as the lower thread.
- ② **Spool pin (Page 16, 21)**
This holds the spool of thread.
- ③ **Thread guide (Page 16, 21)**
This is used when winding the thread onto the bobbin and then threading the machine.
- ④ **Thread take-up lever (Page 21)**
- ⑤ **Hole for extra spool pin (Page 25)**
This holds a second spool of thread for sewing with the twin needle.
- ⑥ **Stitch width dial (Page 15)**
This controls the stitch width.
- ⑦ **Upper tension-control dial (Page 25)**
This controls the tension of the upper thread.
- ⑧ **Thread cutter (Page 28)**
Pass the threads through the thread cutter to cut them.
- ⑨ **Needle threader (Page 22)**
(This is only available on certain models.)
- ⑩ **Quick-set bobbin (Page 19)**
(This is only available on certain models.)
- ⑪ **Flat bed attachment with accessory compartment (Page 10)**
- ⑫ **Presser foot (Page 9)**
- ⑬ **Reverse sewing lever (Page 15)**
You can push this to stitch in the reverse direction.
- ⑭ **Pattern selection dial (Page 11)**
You can turn this in either direction to choose the stitch you want.
- ⑮ **Stitch length dial (Page 14)**
This controls the stitch length.
- ⑯ **Buttonhole fine-adjustment screw (Page 36)**
- ⑰ **Handwheel**
Used to manually raise and lower the needle.
- ⑱ **Main power and sewing light switch (Page 8)**
You can turn the main power and sewing light switch on and off.
- ⑲ **Foot controller jack / socket (Page 7)**
Plug in the foot controller plug and connect the machine to the power supply.
- ⑳ **Presser foot lever (Page 21)**
Used to raise and lower the presser foot.
- ㉑ **Buttonhole lever (1-Step automatic buttonhole) (Page 34)**
Lower the buttonhole lever when sewing buttonholes.
- ㉒ **Foot controller (Page 8)**
You can use this to control the sewing speed, and to start and stop sewing.

Parts Code for Zigzag Presser Foot: XC4901-051

Foot Controller: Model KD-1902

Parts Code: XC7359-022 (110/120V Area)

XC7438-222 (220/240V Area)

XC7456-222 (U.K.)

XC7455-022 (Australia, New Zealand)

ACCESSORIES

The following accessories are stored in the flat bed attachment. We have designed these accessories to help you easily perform most sewing tasks.

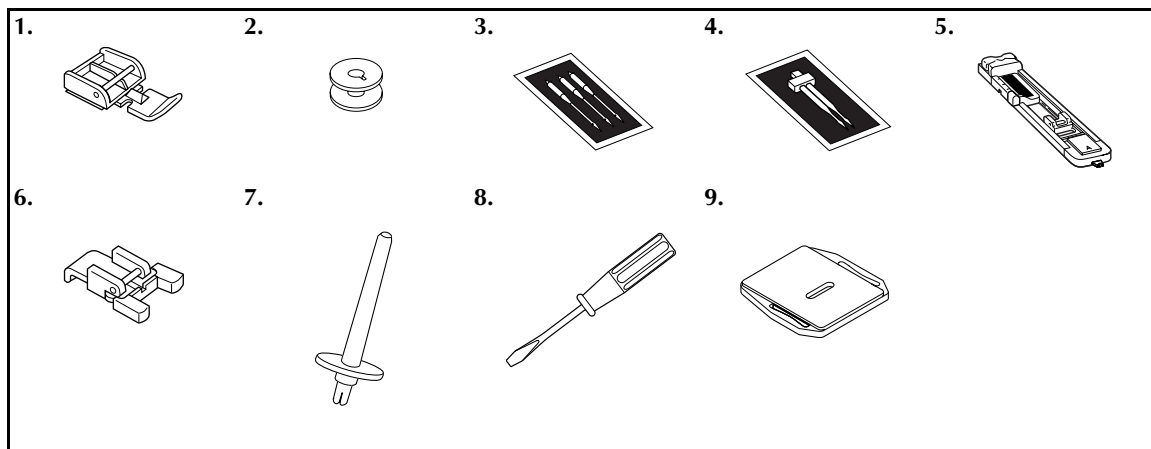

No.	Part Name	Part Code		No.	Part Name	Part Code	
		USA	Others			USA	Others
1	Zipper foot (1 pc.)	X59370-021		5	Buttonhole Foot (1 pc.)	XD1792-031	
2	Bobbin (3 pcs.)	SA156	SFB: XA5539-151	6	Button Sewing Foot (1 pc.)	X59375-121	
				7	Extra Spool Pin (1 pc.)	130920-021	
3	Needle Pack (Regular Single Needle HAX130 (3 pcs.))	129583-021		8	Screwdriver (1 pc.)	X55467-021	
4	Twin Needle (1 pc.)	X57521-021		9	Darning Plate (1pc.)	XC6063-021	



Note

- The included accessories vary depending on the machine model.

Optional Accessories

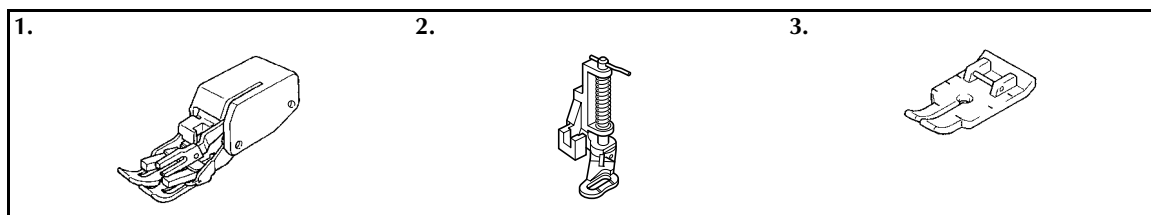

No.	Part Name	Part Code	
		U.S.A.	Others
1	Walking Foot	SA107	F034N: XC2165-002
2	Quilting Foot	SA129	F005N: XC1948-002
3	1/4-inch Quilting Foot	SA125	F001N: XC1944-002

USING YOUR SEWING MACHINE

⚠ WARNING

- Use only regular household electricity for the power source. Using other power sources may result in fire, electric shock, or damage to the machine.
- Turn off the main power and remove the plug in the following circumstances:
 - When you are away from the machine
 - After using the machine
 - When the power fails during use
 - When the machine does not operate correctly due to a bad connection or a disconnection
 - During electrical storms

⚠ CAUTION

- Do not use extension cords or multi-plug adapters with many other appliances plugged in to them. Fire or electric shock may result.
- Do not touch the plug with wet hands. Electric shock may result.
- When unplugging the machine, always turn off the main power first. Always grasp the plug to remove it from the outlet. Pulling on the cord may damage the cord, or lead to fire or electric shock.
- Do not allow the power cord to be cut, damaged, modified, forcefully bent, pulled, twisted, or bundled. Do not place heavy objects on the cord. Do not subject the cord to heat. These things may damage the cord and cause fire or electric shock. If the cord or plug is damaged, take the machine to your authorized dealer for repairs before continuing use.
- Unplug the power cord if the machine is not to be used for a long period of time, otherwise a fire may result.

Connecting Plugs

- 1** Connect the foot controller plug to the machine.
- 2** Connect the power supply plug to a wall outlet.

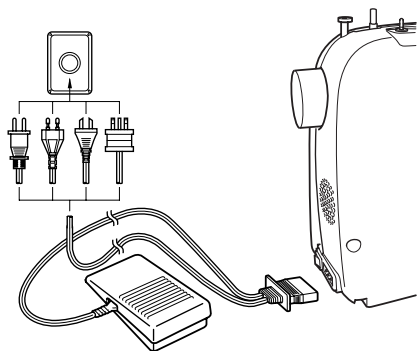

⚡ Note

- When leaving the machine unattended, the main switch of the machine should be switched off or the plug must be removed from the wall outlet.
- When servicing the machine, or when removing covers or changing bulbs, the machine must be unplugged.

(For U.S.A. only)

- This appliance has a polarized plug (one blade wider than the other). To reduce the risk of electric shock, this plug is intended to fit in a polarized outlet only one way. If the plug does not fit fully in the outlet, reverse the plug. If it still does not fit, contact a qualified electrician to install the proper outlet. Do not modify the plug in any way.

Main Power and Sewing Light Switch

This switch turns the main power and sewing light on or off.

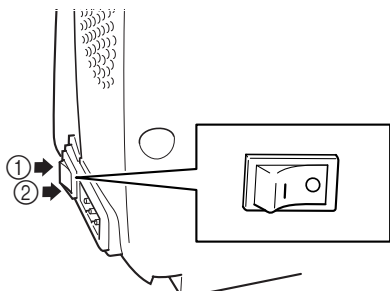

- ① Turn on (toward the 'I' mark)
- ② Turn off (toward the 'O' mark)

Foot Controller

When you press the foot controller down lightly, the machine will run at a low speed. When you press harder, the machine's speed will increase. When you take your foot off the foot controller, the machine will stop. You should make sure that nothing is placed on the foot controller when the machine is not in use.

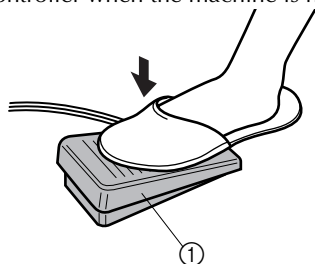

- ① Foot controller

CAUTION

- Do not allow pieces of cloth and dust to build up on the foot controller. Doing so could cause a fire or an electric shock.



Note

(For U.S.A. only)

- Foot Controller: Model KD-1902
This foot controller can be used on the following machine models:
XL-3500, XL-3500i
XL-2600, XL-2600i
XL-3510, XL-3510i
XL-2610, XL-2610i
XL-3520, XL-3520i
XL-2620, XL-2620i

Checking the Needle

The sewing needle must always be straight and sharp for smooth sewing.

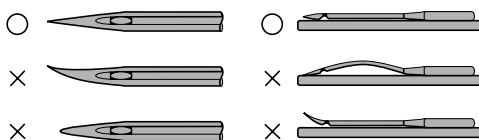

Checking the Needle Correctly

Put the flat side of the needle on a flat surface. Check the needle from the top and the sides. Dispose of any bent needles safely.

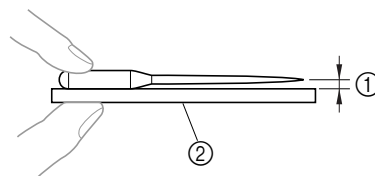

- ① Parallel space
- ② Level surface (bobbin cover, glass, etc.)

Replacing the Needle

CAUTION

- Turn the main power switch off before you change the needle. If you leave the main power on and step on the foot controller, the machine will start and you may be injured.
- Only use sewing machine needles for home use. Other needles may bend or break and cause injury.
- Never sew with a bent needle. A bent needle will easily break and cause injury.

- 1 Remove the power supply plug from the outlet.
- 2 Raise the needle to its highest position by turning the handwheel toward you (counterclockwise) so that the mark on the handwheel points directly up.

- 3 Lower the presser foot lever.

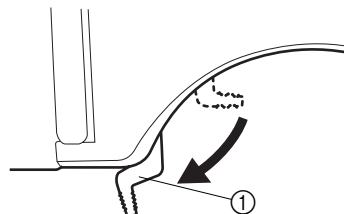

- ① Presser foot lever

- 4** Hold the needle with your left hand, and then use a coin or screwdriver to turn the needle clamp screw counterclockwise to remove the needle.

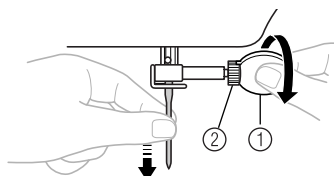

- ① Use a coin or screwdriver
- ② Needle clamp screw

- Do not use excessive force when loosening or tightening the needle clamp screw, otherwise certain parts of the sewing machine may be damaged.

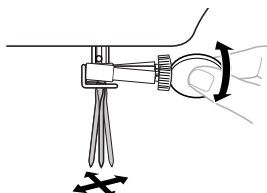

- 5** With the flat side of the needle toward the back of the machine, insert the needle until it touches the needle stopper. Next, tighten the needle clamp using a coin or screwdriver.

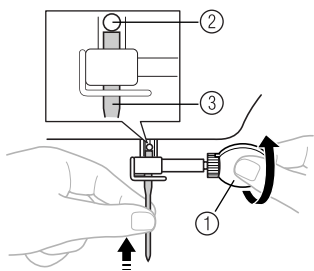

- ① Use a coin or screwdriver
- ② Needle Stopper
- ③ Needle

Put the twin needle in the same way.

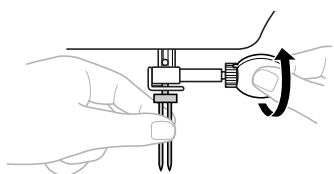

! CAUTION

- Make sure you insert the needle until it touches the stopper, and securely tighten the needle clamp screw with a coin or screwdriver. If the needle is not fully inserted, or if the needle clamp screw is loose, the needle may break or the machine may be damaged.

Changing the Presser Foot

! CAUTION

- Always turn off the power before you change the presser foot. If you leave the power on and step on the controller, the machine will start and you may be injured.
- Always use the correct presser foot for the stitch pattern you have chosen. If you use the wrong presser foot, the needle may strike the presser foot and bend or break, and may cause injury.
- Only use presser feet that have been designed to be used with this machine. Using any other presser foot may cause accident or injury.

You will have to change the presser foot depending on what you want to sew and how.

■ Snap-on Type

- 1** Raise the needle to its highest position by turning the handwheel toward you (counterclockwise), and then raise the presser foot lever.
- 2** Press the black button at the back of the presser foot holder to release the presser foot.

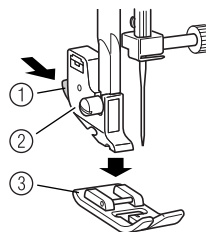

- ① Black button
- ② Presser foot holder
- ③ Presser Foot

3 Put a different presser foot on the needle plate so that the bar on the presser foot is in line with the slot on the shank.

4 Lower the presser foot lever and fix the presser foot onto the shank. If the presser foot is in the correct place, the bar should snap in.

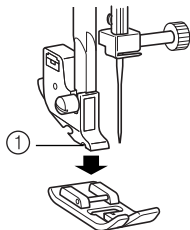

① Shank

■ Presser Foot Installation Orientation

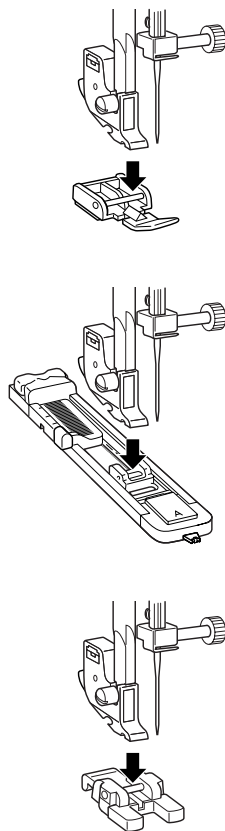

⚠ CAUTION

● If the presser foot is not installed with the correct orientation, the needle may strike the presser foot, which may bend or break the needle and cause injury.

Flat Bed Attachment

The accessories are stored in a compartment inside the flat bed attachment.

1 Slide the flat bed attachment to the left to open it.

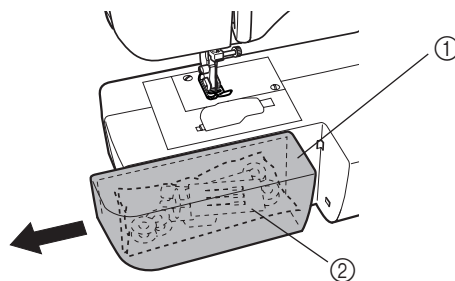

① Flat bed attachment
② Storage compartment

Note

● Put the accessories inside a bag, and then store the bag inside the compartment. If the accessories are not in a bag, they may fall out and be lost or damaged.

Using a Free-arm Style

Free-arm sewing is convenient for sewing tubular and hard-to-reach areas. To change your machine to the free-arm style, lift out the flat bed attachment.

1 Slide the flat bed attachment to the left to release it.

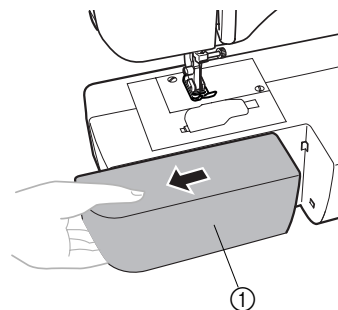

① Flat bed attachment

THE CONTROLS

Pattern Selection Dial

CAUTION

- When you use the pattern selection dial to choose a pattern, turn the handwheel toward you (counterclockwise) to set the needle in the highest position. If the needle is in the down position when you turn the pattern selection dial, the needle, presser foot or fabric may be damaged.

To choose a stitch, simply turn the pattern selection dial in either direction. The next section shows recommended stitch lengths and widths.

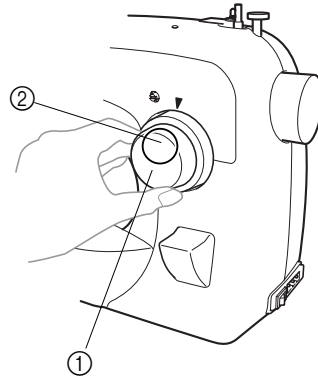

- ① Pattern selection dial
- ② Chosen pattern number

35 Stitches (only available on certain models)

1	2	3	4	5	6	7	8	9	10	11	12	13
---	---	---	---	---	---	---	---	---	----	----	----	----

SS1

14	15	16	17	18	19	20	21	22	23	24	25
----	----	----	----	----	----	----	----	----	----	----	----

SS2

26	27	28	29	30	31	32	33	34	35
----	----	----	----	----	----	----	----	----	----

25 Stitches

1	2	3	4	5	6	7	8	9	10	11	12	13
---	---	---	---	---	---	---	---	---	----	----	----	----













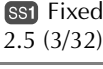
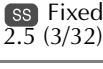

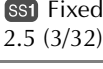
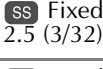



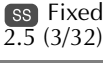



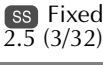

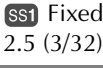
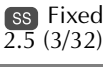

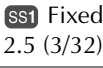
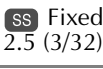

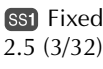
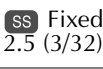
SS

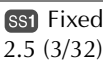
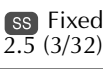

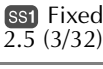
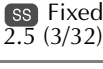





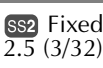





14	15	16	17	18	19	20	21	22	23	24	25
----	----	----	----	----	----	----	----	----	----	----	----

Patterns and Stitch Names

Pattern		Stitch Name	Recommended Width (mm (inch))	Recommended Length (mm (inch))	Instruction Manual Page
35 Stitches	25 Stitches				
		1-STEP AUTOMATIC BUTTONHOLE	3-5 (1/8 – 3/16)	F- 1.5 (1/64-1/16)	34
		STRAIGHT STITCH	0-5 (0-3/16) (Changes needle position)	1-4 (1/16-3/16)	27, 37, 38, 41, 42, 43
		ZIGZAG STITCH	0-5 (0-3/16)	F-4 (1/64-3/16)	28, 36, 39, 41
		BLIND HEM STITCH	3-5 (1/8-3/16)	F-2 (1/64-1/16)	29
		SHELL TUCK STITCH	3-5 (1/8-3/16)	F-3 (1/64-1/8)	29
		ELASTIC STITCH	3-5 (1/8-3/16)	F-2.5 (1/64-3/32)	30
		STRETCH BLIND HEM STITCH	3-5 (1/8-3/16)	F-1.5 (1/64-1/16)	29
		STRETCH BLIND HEM STITCH	3-5 (1/8-3/16)	F-1.5 (1/64-1/16)	29
		ELASTIC SHELL TUCK STITCH	3-5 (1/8-3/16)	F-3 (1/64-1/8)	31
		DOUBLE ACTION STITCH	3-5 (1/8-3/16)	F-3 (1/64-1/8)	31
		BRIDGING STITCH	3-5 (1/8-3/16)	F-3 (1/64-1/8)	31
		RAMPART STITCH	3-5 (1/8-3/16)	F-3 (1/64-1/8)	31
		TRIANGLE STITCH	3-5 (1/8-3/16)	F- 1.5 (1/64-1/16)	33
		TRIPLE STRETCH STITCH	0-5 (0-3/16) (Changes needle position)	SS1 Fixed 2.5 (3/32)*	27
				SS Fixed 2.5 (3/32)	
		TRIPLE ZIGZAG STRETCH STITCH	3-5 (1/8-3/16)	SS1 Fixed 2.5 (3/32)*	32
				SS Fixed 2.5 (3/32)	
		STRETCH OVERLOCK STITCH	3-5 (1/8-3/16)	SS1 Fixed 2.5 (3/32)	31
				SS Fixed 2.5 (3/32)	

* The stitch can also be sewn when the stitch length dial is set to **SS2**.

Pattern		Stitch Name	Recommended Width (mm (inch))	Recommended Length (mm (inch))	Instruction Manual Page
35 Stitches	25 Stitches				
17 	17 	ELASTIC OVERLOCK STITCH	3-5 (1/8-3/16)		31
					
18 	18 	FEATHER STITCH	3-5 (1/8-3/16)		32
					
19 	19 	ARROWHEAD STITCH	3-5 (1/8-3/16)		31
					
20 	20 	ARROWHEAD STITCH	3-5 (1/8-3/16)		31
					
21 	21 	DECORATIVE STITCH	3-5 (1/8-3/16)		33
					
22 	22 	LEAF STITCH	3-5 (1/8-3/16)		33
					
23 	23 	TREE STITCH	3-5 (1/8-3/16)		33
					
24 	24 	LEGS STITCH	3-5 (1/8-3/16)		33
					
25 	25 	DECORATIVE STITCH	3-5 (1/8-3/16)		33
					
26 	—	STRETCH OVERLOCK STITCH	3-5 (1/8-13/64)		33
27 	—	STRETCH OVERLOCK STITCH	3-5 (1/8-13/64)		33
28 	—	SMOCKING STITCH	3-5 (1/8-13/64)		31

Pattern		Stitch Name	Recommended Width (mm (inch))	Recommended Length (mm (inch))	Instruction Manual Page
35 Stitches	25 Stitches				
	—	COMB STITCH	3-5 (1/8-3/16)	 Fixed 2.5 (3/32)	31
	—	COMB STITCH	3-5 (1/8-3/16)	 Fixed 2.5 (3/32)	31
	—	DECORATIVE STITCH	3-5 (1/8-3/16)	 Fixed 2.5 (3/32)	33
	—	FAGOTING STITCH	3-5 (1/8-13/64)	 Fixed 2.5 (3/32)	31
	—	DECORATIVE STITCH	3-5 (1/8-3/16)	 Fixed 2.5 (3/32)	31
	—	DECORATIVE HEM STITCH	3-5 (1/8-3/16)	 Fixed 2.5 (3/32)	33
	—	DECORATIVE STITCH	3-5 (1/8-3/16)	 Fixed 2.5 (3/32)	33

Stitch Length Dial

Depending on the selected stitch, you may need to adjust the stitch length for best results. The numbers marked on the stitch length dial represent the stitch length in millimeters (mm) (1/25 inch). THE HIGHER THE NUMBER, THE LONGER THE STITCH. With the “0” setting, material is not fed. This is used when sewing a button. The “F” range is for making a satin stitch (close zigzag stitch), which is used for making buttonholes and decorative stitches. The position needed for making the satin stitch varies according to the material and thread being used. To determine the exact dial position, first test the stitch and length settings on a scrap piece of fabric to observe the feeding of the material.

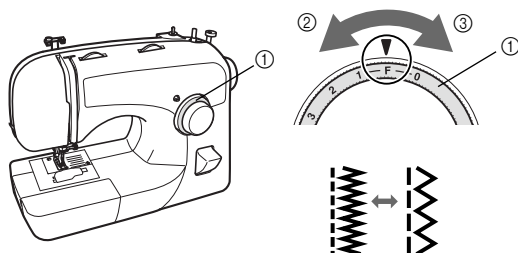

- ① Stitch length dial
- ② Shorter
- ③ Longer

CAUTION

- If the stitches are bunched together, lengthen the stitch length and continue sewing. Do not continue sewing without lengthening the stitch length, otherwise the needle may break and cause injury.

Stretch Stitching

Raise the needle to its highest position by turning the handwheel toward you (counterclockwise) so that the mark on the handwheel points directly up.

■ 35 Stitches

Selecting a Stretch Stitch

Setting the stitch length dial to "SS1" or "SS2" changes the selected pattern to a stretch stitch.



■ 25 Stitches

Selecting a Stretch Stitch

Setting the stitch length dial to "SS" changes the selected pattern to a stretch stitch.



Stitch Width Dial

Raise the needle to its highest position by turning the handwheel toward you (counterclockwise) so that the mark on the handwheel points directly up.

The numbers marked on the dial represent the stitch width.

THE HIGHER THE NUMBER, THE WIDER THE STITCH.



Note

- When the Straight or Triple Stretch Stitch is selected, the needle position can be changed from left to right by adjusting the stitch width dial.

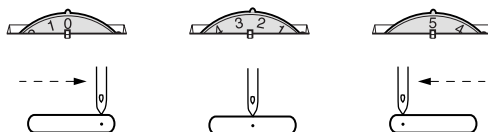
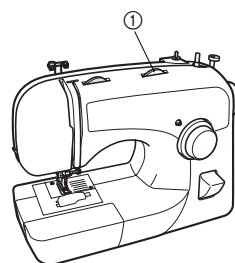

① Stitch width dial

Reverse Sewing Lever

You can use reverse sewing for back tacking and reinforcing seams.

To sew in reverse, push the reverse sewing lever in as far as possible and hold it in that position while you lightly push the foot controller. To sew forward, release the reverse sewing lever. The machine will then sew forward.

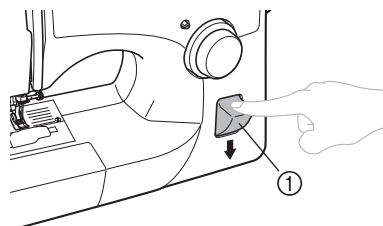

① Reverse sewing lever

THREADING THE MACHINE

Winding the Bobbin

⚠ CAUTION

- Only use bobbins (part code: SA156, SFB (XA5539-151)) that have been designed for this sewing machine. Using other bobbins may cause damage to the machine.
- We designed the bobbin that comes with this machine. If you use bobbins from other models, the machine will not work properly. Only use the bobbin that comes with this machine or bobbins of the same type (part code: SA156, SFB (XA5539-151)).

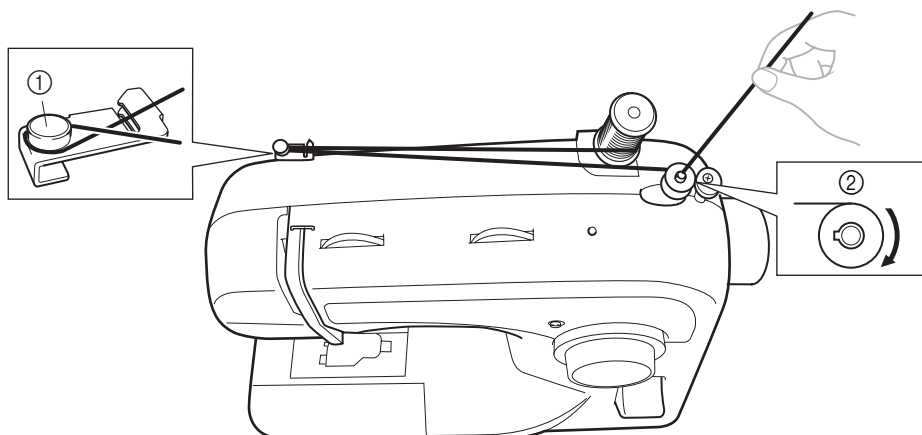
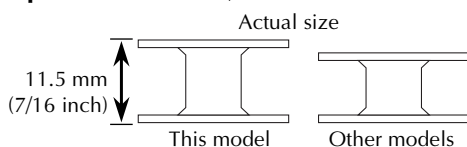

- ① Pre-tension disk
② Bobbin winder shaft

- 1** Put the spool of thread on the spool pin and pass the thread around the pre-tension disk.

- 2** Pass the end of the thread through the hole on the bobbin from the inside of the bobbin.

⚠ CAUTION

- If the spool of thread is not in the right place, the thread may tangle on the spool pin.

- 3** Put the bobbin onto the bobbin winder shaft and slide the bobbin winder shaft to the right. Turn the bobbin clockwise, by hand, until the spring on the shaft slides into the groove of the bobbin.

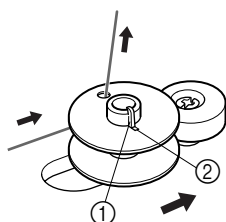

- ① Spring on the shaft
② Groove of the bobbin



Note

- Make sure that the thread between the spool and the bobbin is pulled tight.

- 4** While holding the end of the thread, gently press the foot controller to wind the thread around the bobbin a few times. Then stop the machine.

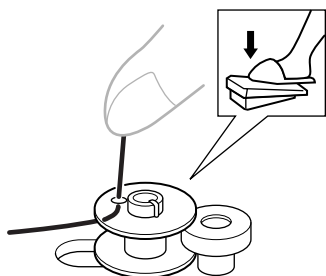

- 5** Trim the excess thread above the bobbin.

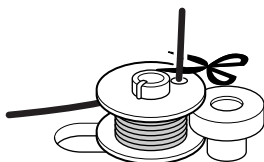

- 6** Press the foot controller to start.

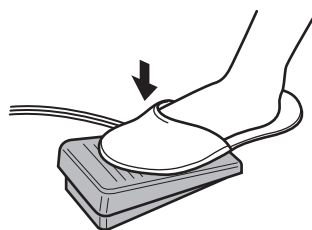

- 7** When the bobbin seems full and begins spinning slowly, take your foot off the foot controller.

- 8** Cut the thread, slide the bobbin winder shaft to the left and remove the bobbin.



Note

- The needle bar does not move when you slide the bobbin winder shaft to the right.
- Immediately after winding the bobbin, it is normal to hear the sound of the clutch engaging when beginning to sew or turning the handwheel.

CAUTION

- Make sure you follow the instructions carefully. If you do not cut the excess thread completely before winding the bobbin, when the thread runs low it may tangle around the bobbin and cause the needle to break.

CAUTION

- Not winding the bobbin properly may cause the thread tension to loosen, and may break the needle.

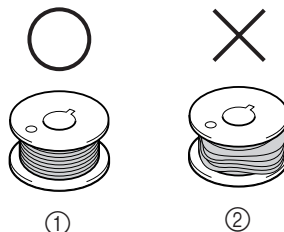

- ① Wound evenly
② Wound poorly

Lower Threading

- For more details on using the quick-set bobbin, see page 19.

CAUTION

- Not winding the bobbin properly may cause the thread tension to loosen, and may break the needle.

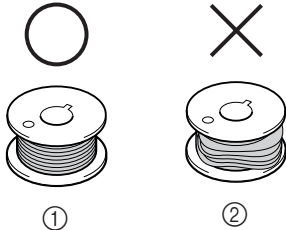

- ① Wound evenly
- ② Wound poorly

- The bobbin was designed specifically for this sewing machine. If bobbins from other models are used, the machine will not operate correctly. Use only the enclosed bobbin or bobbins of the same type (part code: SA156, SFB (XA5539-151)).

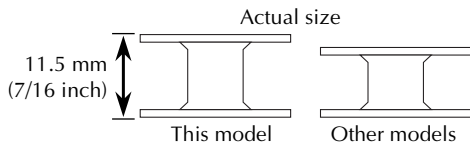

CAUTION

- Make sure you turn the power off while threading the machine. If you accidentally step on the foot controller and the machine starts to sew, you could be injured.

- 1 Raise the needle to its highest position by turning the handwheel toward you (counterclockwise) and raise the presser foot lever.

- 2 Slide the button and open the cover.

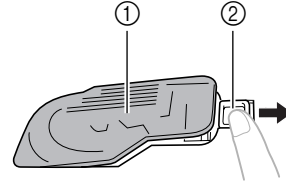

- ① Cover
- ② Slide button

- 3 Put the bobbin in so the thread comes out in the direction shown by the arrow.

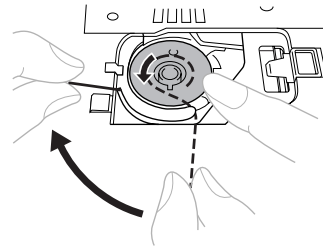

- Only use bobbins that were designed to be used with this machine.

CAUTION

- Make sure you set the bobbin so the thread unrolls in the right direction. If the thread unrolls in the wrong direction, it may cause the thread tension to be incorrect or break the needle.

- Make sure that the thread is correctly inserted through the tension-adjusting spring of the bobbin case. If it is not inserted, re-insert the thread.

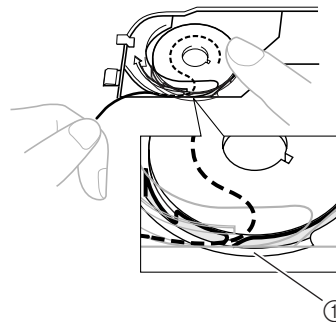

- ① Tension-adjusting spring

- 4** Hold the end of the thread, push the bobbin down with your finger, pass the thread through the slit, and then pull out a short length of thread, as shown.

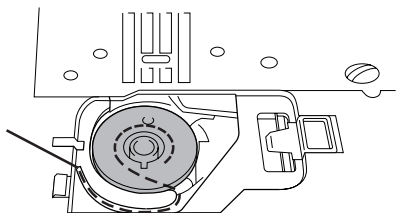

- 5** Reattach the bobbin cover. Put the left tab in place (see arrow ①), and then press lightly on the right side (see arrow ②) until the cover clicks into place.

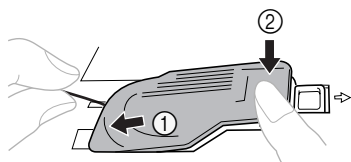

- Replace the cover so that the end of the thread comes out from the left side of the cover (as shown by the line in the illustration).

Lower Threading (for models equipped with a quick-set bobbin)

This feature is only available on certain models.

⚠ CAUTION

- Winding the bobbin improperly may cause the thread tension to loosen, breaking the needle and resulting in injury.

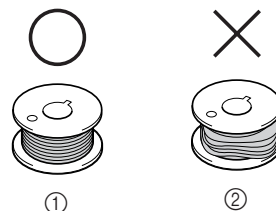

- ① Wound evenly
② Wound poorly

- The bobbin was designed specifically for this sewing machine. If bobbins from other models are used, the machine will not operate correctly. Use only the enclosed bobbin or bobbins of the same type (part code: SA156, SFB (XA5539-151)).

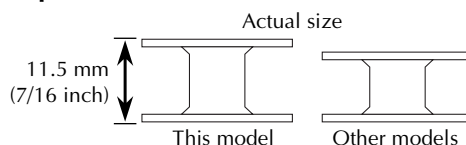

⚠ CAUTION

- Be sure to turn off the power. If you accidentally step on the foot controller and the machine begins to operate, injury could result.

1 Follow steps **1** and **2** from “Lower Threading”.

2 Put the bobbin in, feed the end of the thread through the slit, and then pull the thread to cut it.

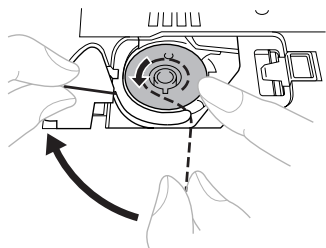

- Only use bobbins that were designed to be used with this machine.

CAUTION

● Make sure you set the bobbin so the thread unrolls in the right direction. If the thread unrolls in the wrong direction, it may cause the thread tension to be incorrect or break the needle.

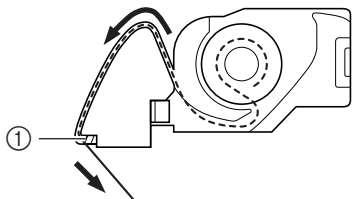

① Cutter

- Make sure that the thread is correctly inserted through the tension-adjusting spring of the bobbin case. If it is not inserted, re-insert the thread.

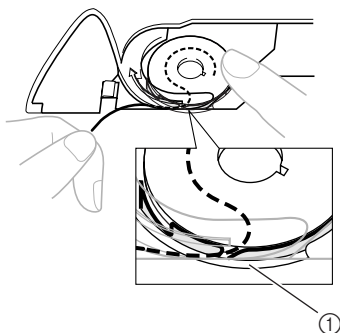

① Tension-adjusting spring

3 Reattach the bobbin cover. Put the left tab in place (see arrow ①), and then press lightly on the right side (see arrow ②) until the cover clicks into place.

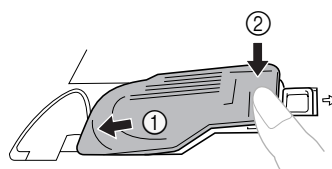

- You can begin sewing immediately without drawing up the bobbin thread. If you want to draw up the bobbin thread before you start to sew, follow the procedure in “Drawing up the Lower Thread” (page 24).

Upper Threading

1

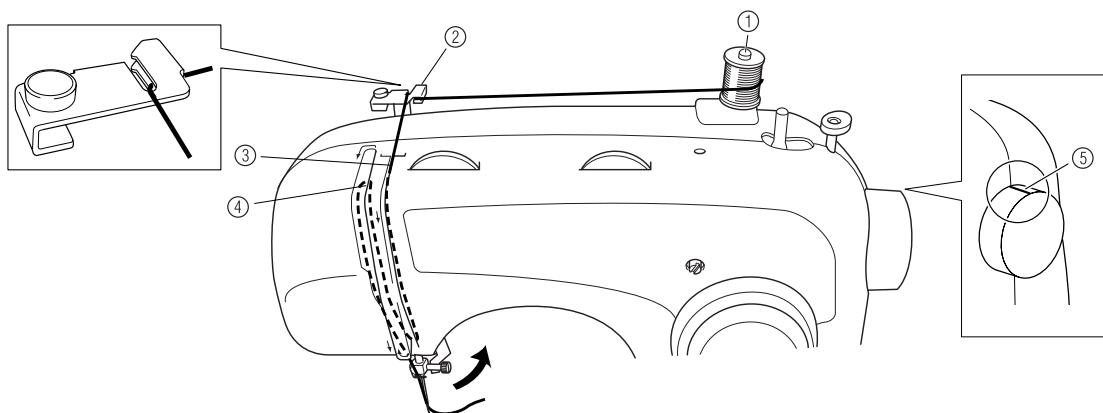

- ① Spool pin
- ② Thread guide (back)
- ③ Thread guide (front)
- ④ Thread take-up lever
- ⑤ Mark on the handwheel

⚠ CAUTION

- Make sure you thread the machine properly. Otherwise, the thread could tangle and break the needle.

- 1** **IMPORTANT:**
Raise the presser foot using the presser foot lever.

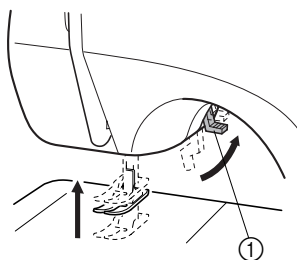

- ① Presser foot lever

- 2** Raise the needle to its highest position by turning the handwheel toward you (counterclockwise) so that the mark on the handwheel points directly up.
- If the needle is not correctly raised, the sewing machine can not be threaded. Be sure to turn the handwheel so that the mark on the wheel points up before threading the sewing machine.

- 3** Pull up the spool pin and put a spool of thread on this pin.

⚠ CAUTION

- If the spool of thread is in the wrong place, or is set incorrectly, the thread may tangle on the spool pin and cause the needle to break.

- 4** Feed the upper thread as previously shown. Pass the thread through both thread guides: the back one first, and then the front one.

- 5** Make sure you guide the thread through the thread take-up lever from right to left.

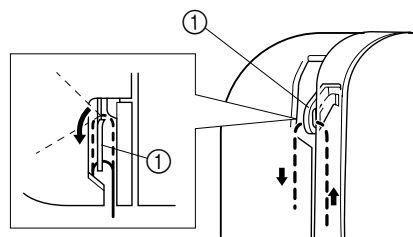

- ① Thread take-up lever

- 6** Put the thread behind the guide above the needle.
- The thread can easily be passed behind the needle bar thread guide by holding the thread in your left hand, then feeding the thread with your right hand.

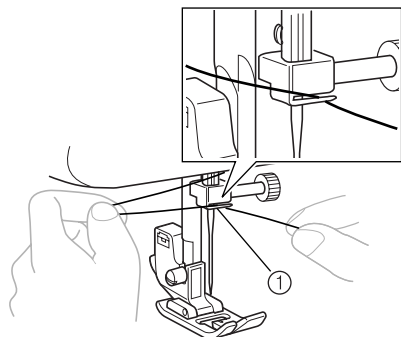

① Needle bar thread guide

- 7** **IMPORTANT:** Thread the needle from front to back leaving a thread tail of about 5 cm (2 inch).

- If your sewing machine is equipped with a needle threader, use the needle threader to thread the needle (see next section).

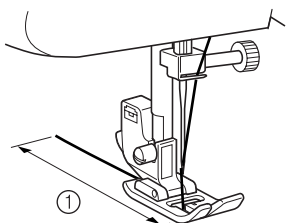

① 5 cm (2 inch)

Note

- If the thread take-up lever is lowered, the upper thread can not be wrapped around the thread take-up lever. Make sure you raise the presser foot lever and the thread take-up lever before you feed the upper thread.
- If you incorrectly feed the thread you may cause sewing problems.

Using the Needle Threader (for models equipped with a needle threader)

This feature is only available on certain models.

- 1** Turn the power off and lower the presser foot lever.
- 2** Raise the needle to its highest position by turning the handwheel toward you (counterclockwise) so that the mark on the handwheel points directly up.

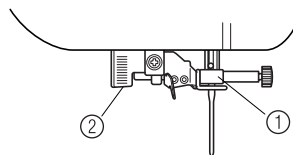

① Needle holder
② Needle threader lever

Note

- When you use the needle threader, make sure the needle holder is in the highest position, otherwise the hook may be damaged.

- 3** While lowering the needle threader lever, hook the thread onto the guide.

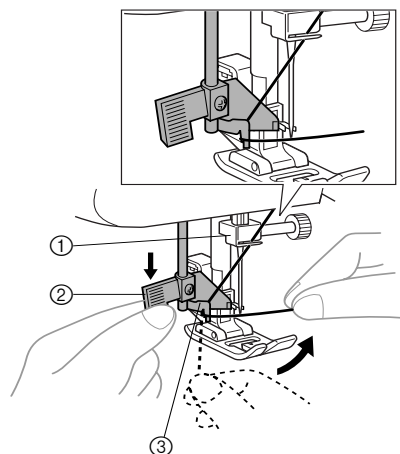

① Needle holder
② Needle threader lever
③ Guide

- 4** Pull down the needle threader lever as much as possible, and then turn the lever toward the back of the machine (away from you). Make sure that the hook passes through the eye of the needle and grabs the thread.

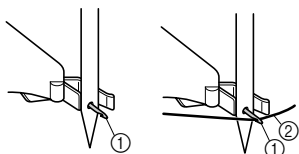
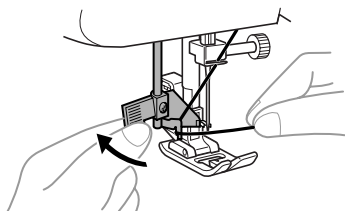

- ① Hook
② Thread

- Hold the thread in front of the needle to make sure that the hook grabs it.

- 5** While lightly holding the thread, turn the needle threader lever toward the front of the machine (toward you). The hook will pull the thread through the needle.

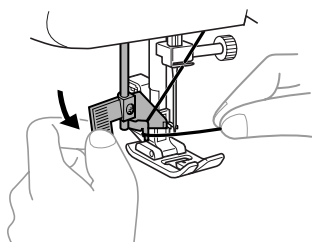

- 6** Raise the needle threader lever and pull out about 5 cm (2 inch) of thread through the needle toward the back of the sewing machine.

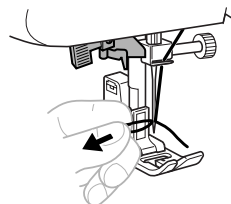
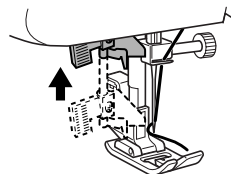

! CAUTION

- The needle threader can only be used with home sewing machine needles size 75/11-100/16. Check the table on page 26 for the appropriate needle and thread combinations. If you are using transparent nylon mono-filament thread, you can only use needles in the range of 90/14-100/16.
- You can not use the needle threader if you are using decorative threads or special needles, such as the twin needle and wing needle. When using these needles or threads you will need to thread the needle by hand. Make sure the main power switch is off when threading.

Drawing up the Lower Thread

- 1 While lightly holding the end of the upper thread, slowly turn the handwheel toward you (counterclockwise) by hand to lower and then raise the needle.

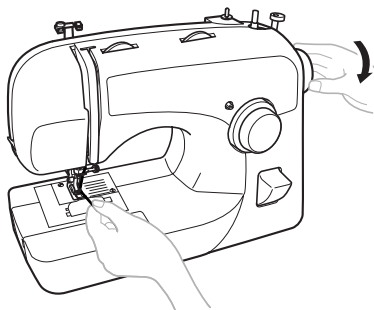

- 2 Pull on the upper thread to draw up the lower thread.

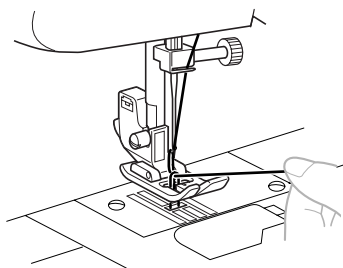

- 3 Pull out about 10 cm (4 inch) of both threads and put them toward the back of the machine under the presser foot.

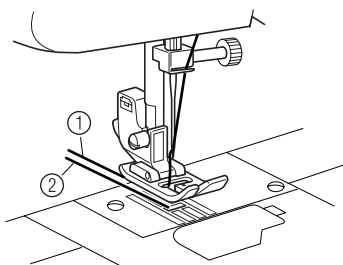

- ① Upper thread
- ② Lower thread

Quick-set Bobbin Threading

This is only available on certain models.

You can begin sewing immediately without drawing up the bobbin thread. When sewing gathers or darts, you can draw up the lower thread by hand so that some thread will be left over. Before you draw up the lower thread, put the bobbin back in.

- 1 Pass the thread along the slit in the direction of the arrow, and leave it there without cutting it.

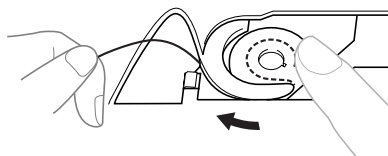

- The bobbin cover should still be removed.

- 2 Draw up the lower thread as described in the previous steps 1 to 3.

- 3 Replace the bobbin cover.

Sewing with a Twin Needle

We have designed your machine so you can sew with this needle and two top threads. You can use the same color or two different colors of thread for making decorative stitches.

! CAUTION

- Use only twin needles that have been made for this machine (part code: X57521-021). Other needles could break and damage the machine.
- When using the twin needle, make sure the stitch width is not set above 3 since this may cause the needle to hit the needle plate and break.
- Make sure that the needle does not strike the presser foot.
- Do not sew with bent needles. The needle could break and injure you.
- When using the twin needle, make sure you use the zigzag presser foot only.

■ Attaching the Twin Needle

Attach the twin needle in the same way as a single needle (see page 8). The flat side of the needle should face toward the back and the rounded side should face toward you.

■ Attaching the Extra Spool Pin

Put the extra spool pin in the hole on the top of the machine. Put the second spool of thread onto the extra spool pin.

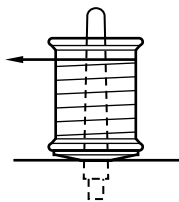

■ Twin Needle Threading

You should thread each needle separately.

1 Thread the left needle.
Follow the same instructions for threading a single needle (see page 21).

2 Thread the right needle.
Thread the right needle in the same way that you threaded the left needle using the thread from the spool on the extra spool pin, but do not pass the thread through the guide above the needle before you pass it through the eye of the right needle.

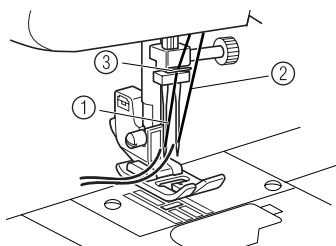

- ① Left needle thread passes through the needle bar thread guide
- ② Right needle thread passes in front of the needle bar thread guide
- ③ Needle bar thread guide



Note

Models Equipped with a Needle Threader

- You can not use the needle threader to thread the twin needle. Instead, thread the twin needle by hand, from front to back. Using the needle threader may damage the machine.

Thread Tension

The tension of the thread will affect the quality of your stitches. You may need to adjust it when you change fabric or thread.



Memo

- We recommend that you do a test sample on scrap of a fabric before you start to sew.

■ Correct Tension

Correct tension is important as too much or too little tension will weaken your seams or cause puckers on your fabric.

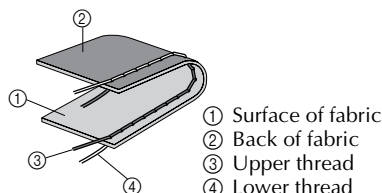

■ Upper Tension is too Tight

Loops will appear on the surface of the fabric.

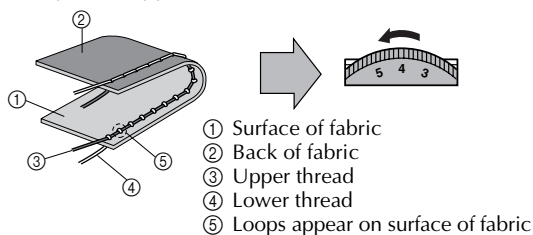

Solution

Reduce the tension by turning the upper tension control dial to a lower number.

■ Upper Tension is too Loose

Loops appear on the back of the fabric.

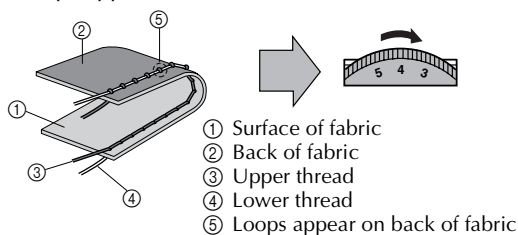

Solution

Increase the tension by turning the upper tension control dial to a higher number.



Note

- If the upper thread is not threaded correctly or the bobbin is not installed correctly, it may not be possible to set the correct thread tension. If the correct thread tension cannot be achieved, rethread the upper thread and insert the bobbin correctly.

FABRIC, THREAD, AND NEEDLE COMBINATIONS

Fabric Type		Thread		Size of Needle
		Type	Size	
Medium weight fabrics	Broadcloth	Cotton	60–80	75/11–90/14
	Taffeta	Thread synthetic mercerized		
	Flannel, Gabardine	Silk or silk finished	50–80	
Lightweight fabrics	Lawn, Batiste	Cotton	60–80	65/9–75/11
	Georgette	Thread synthetic mercerized		
	Challis, Satin	Silk	50–80	
Heavyweight fabrics	Denim	Cotton	30–50	90/14–100/16
	Corduroy	Thread synthetic mercerized	50	
	Tweed	Silk		
Stretch fabrics	Jersey	Thread for knits	50–60	Ball point needle (golden colored) 75/11–90/14
	Tricot			
For top stitching		Thread synthetic mercerized	30	90/14–100/16
		Silk		



Memo

- For clear nylon thread, always use needle 90/14 - 100/16.
- You can also use the same thread for the bobbin thread and upper threading.

CAUTION

- Make sure you follow the needle, thread, and fabric combinations listed in the table. Using the wrong combination, such as heavyweight fabric like denim with a small needle (65/9-75/11), may bend or break the needle. The wrong combination may also cause the seam to be uneven, the fabric to pucker, or the machine to skip stitches.

Please Read Before Sewing

CAUTION

- To avoid being injured, watch the needle carefully while you are using the machine. Keep your hands away from moving parts.
- Do not stretch or pull the fabric during sewing, otherwise the needle may be damaged and you may be injured.
- Do not use bent or broken needles, otherwise you may be injured.
- Take care that the needle does not hit basting pins or other objects during sewing. The needle may break and you may be injured.
- Always use the correct presser foot. If you use the wrong presser foot, the needle may hit the presser foot and bend or break and you may be injured.
- When you turn the handwheel by hand, always turn it toward you (counterclockwise). Turning it the other way may cause the thread to tangle and damage the needle or fabric, and you may be injured.

Straight Stitching

Stitch Name	Pattern	Stitch Length [mm (inch)]	Stitch Width [mm (inch)]
Straight Stitch	2 	1-4 (1/64-3/16)	5-0* (3/16-0)
Triple Stretch Stitch	14 	SS1 Fixed 2.5 (3/32) SS Fixed 2.5 (3/32)	

*Turn the stitch width dial to adjust the needle position. Setting the dial to 5 selects the left needle position; setting the dial to 0 selects the right needle position.

■ Starting Sewing

- 1 Turn the pattern selection dial to choose the stitch number you want. You also need to set the pattern selection dial to the Straight Stitch or Triple Stretch Stitch.
- 2 Raise the needle to its highest position and lift the presser foot lever.
- 3 Pull the upper thread through the toes of the presser foot.

- 4 Put the fabric under the presser foot and position the needle 1 cm (3/8 inch) from the edge of the fabric.
- 5 Lower the presser foot.
- 6 To back tack, push down the reverse sewing lever as far as possible, and then press the foot controller to start reverse sewing. Release the foot controller to stop sewing.
- 7 Release the reverse sewing lever and start sewing in the forward direction by pressing the foot controller.

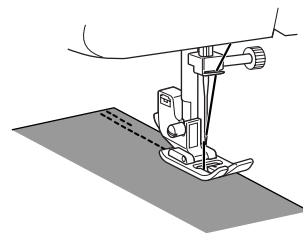

- You can use reverse sewing for locking the end of seams and to strengthen a stitch.

CAUTION

- Make sure the needle does not hit a pin or any other object during sewing. The thread could tangle or the needle could break, and you may be injured.

■ Changing Sewing Direction

- 1 Stop the machine at the point where you want to change direction with the needle still in the fabric.
- 2 Raise the presser foot and turn the fabric to its new direction using the needle as a pivot.

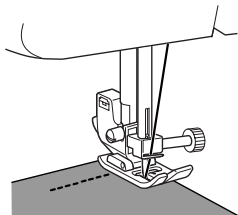

- 3 Lower the presser foot and start sewing in the new direction.

■ Finishing Sewing

You can use stitching to lock the threads at the end of the seam or to strengthen a stitch.

- 1 Stitch to the end of the seam and stop.
- 2 Push the reverse sewing lever and stitch backwards for 1 cm (3/8 inch) from the end of the fabric.

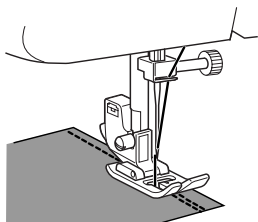

■ Removing the Material from the Machine

- 1 Stop the machine. Raise the needle to its highest position and make sure that the thread take-up lever is also in its highest position.
- 2 Lift the presser foot, raise the needle to its highest position, and then pull the fabric out gently to the left hand side.
 - Raise the needle to its highest position and make sure that the thread take-up lever is also in its highest position.
- 3 Cut both threads with the thread cutter on the left hand side of the machine

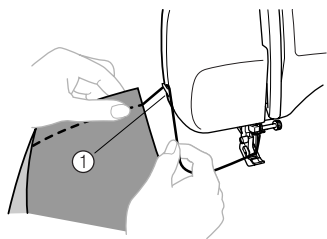

① Thread cutter

- 4 To prepare the machine for the next seam, pull about 10 cm (4 inch) of thread through the toes of the presser foot toward the back of the machine.

■ Top Stitching and Stretch Materials

You can use a straight stitch for top stitching and sewing lightweight fabrics.

You can use a triple stretch stitch for sewing stretch fabrics.

Zigzag Stitching

Stitch Name	Pattern	Stitch Length [mm (inch)]	Stitch Width [mm (inch)]
Zigzag Stitch		F-4 (1/64-3/16)	0-5 (0-3/16)

■ Zigzag Stitch

Turn the pattern selection dial to the Zigzag Stitch, and then start sewing.

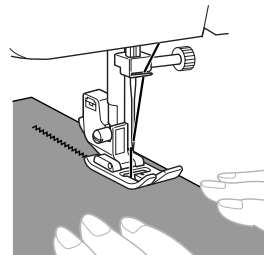

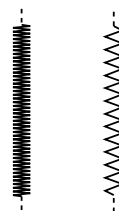

We recommend that you sew using the Straight Stitch at the beginning and end of zigzag stitches. (This acts as a reinforcement stitch.)



■ Satin Stitch

Setting the Zigzag Stitch length in the "F" range produces a satin stitch (close zigzag stitch). The Satin Stitch can be used for making buttonholes and decorative stitches. Set the pattern selection dial to the Zigzag Stitch, set the stitch length in the "F" range, and set the stitch width dial between 0 and 5.

Blind Hem Stitching

Stitch Name	Pattern	Stitch Length [mm (inch)]	Stitch Width [mm (inch)]
Blind Hem Stitch		F-2 (1/64-1/16)	3-5 (1/8-3/16)
Stretch Blind Hem Stitch		F-1.5 (1/64-1/16)	3-5 (1/8-3/16)
Stretch Blind Hem Stitch		F-1.5 (1/64-1/16)	3-5 (1/8-3/16)

You can use the Blind Hem Stitch to finish the edge of a project, like the hem of a pair of trousers, without the stitch showing. Use the Blind Hem Stitch when sewing on non-stretch fabrics, and the Stretch Blind Hem Stitch for stretch fabrics.

- Both threads should be the same color as the fabric.
- Fold back the hem, as shown in Fig. A. Then fold the edge of the fabric as in Fig. B. Leave a 6 mm (15/64 inch) overlap at the edge.
- Set the pattern selection dial to the Blind Hem Stitch or Stretch Blind Hem Stitch, and then set the stitch length.
- Sew on the fold as in Fig. C.

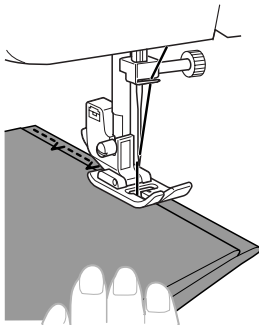

- When the fabric is unfolded you will have a Blind Hem Stitch as shown in Fig. D.

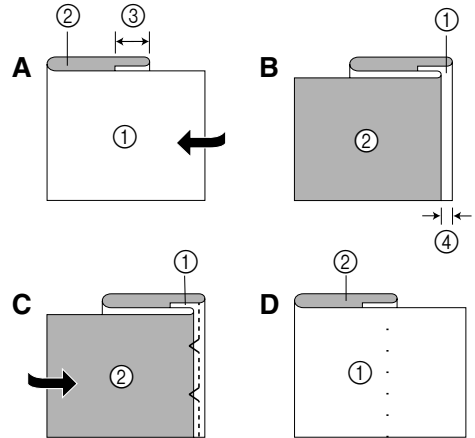

- ① Right side of fabric
- ② Wrong side of fabric
- ③ 10 mm (3/8 inch)
- ④ 5 mm (3/16 inch)



Note

- The Stretch Blind Hem Stitch is useful for stretch fabrics.

Shell Tuck Stitching

Stitch Name	Pattern	Stitch Length [mm (inch)]	Stitch Width [mm (inch)]
Shell Tuck Stitch		F-3 (1/64-1/8)	3-5 (1/8-3/16)

The Shell Tuck Stitch can be used to sew a picot (lace-like) edge on lightweight fabric.

- Set the pattern selection dial to the Shell Tuck Stitch.
- Adjust the thread tension so that it is tighter than normal.
- Place the fabric under the presser foot so that it will be sewn along the bias, with the straight stitches sewn on the seamline and the zigzag stitches sewn slightly over the folded edge.

- 4** Sew at a slow speed.

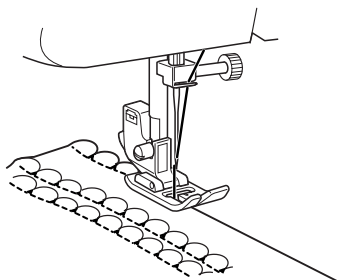

Elastic Stitching

Stitch Name	Pattern	Stitch Length [mm (inch)]	Stitch Width [mm (inch)]
Elastic Stitch		F-2.5 (1/64-3/32)	3-5 (1/8-3/16)

You can use the Elastic Stitch for mending, sewing elastic or joining fabric. Each is explained below. Set the pattern selection dial to the Elastic Stitch.

■ Mending

- 1** Set the stitch length dial between “F” and 2.5.
- 2** Place the reinforcement fabric under the area you want to mend.
- 3** Following the line of the tear, sew using the Elastic Stitch as shown.

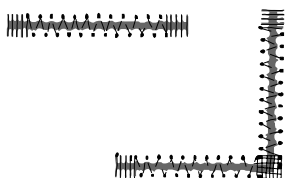

■ Sewing Elastic

- 1** Place the elastic on the fabric.
- 2** As you sew, stretch the elastic in front of and behind the presser foot.

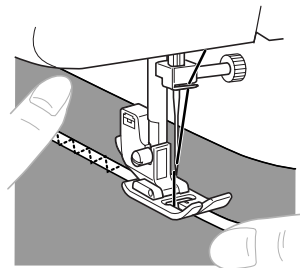



■ Joining Fabric

You can use the Elastic Stitch to join two pieces of fabric together and it is very effective when sewing knitted fabrics. If you are using nylon thread, the stitch will not be visible.

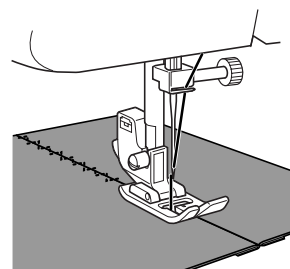
- 1** Put the edge of the two pieces of fabric together and center them under the presser foot.
- 2** Sew them together using the Elastic Stitch. Make sure you keep the two fabric edges close together.





Double Action Stitching

Stitch Name	Pattern	Stitch Length [mm (inch)]	Stitch Width [mm (inch)]
Double Action Stitch		F-3 (1/64-1/8)	3-5 (1/8-3/16)
Bridging Stitch		F-3 (1/64-1/8)	3-5 (1/8-3/16)
Rampart Stitch		F-3 (1/64-1/8)	3-5 (1/8-3/16)

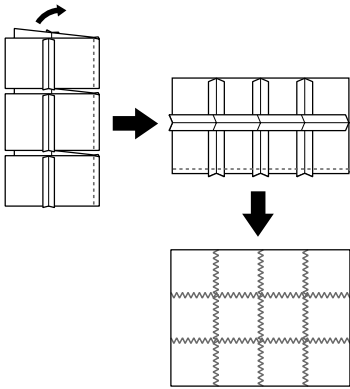
These stitches are used for joining two pieces of fabric, such as when making patchwork. Set the pattern selection dial to the Double Action Stitch, Bridging Stitch, or Rampart Stitch.



Heirloom Stitching

Stitch Name	Pattern	Stitch Length [mm (inch)]	Stitch Width [mm (inch)]
Smocking Stitch		SS2 Fixed 2.5 (3/32)	3-5 (1/8-13/64)
Fagoting Stitch		SS2 Fixed 2.5 (3/32)	3-5 (1/8-13/64)
Decorative Stitch		SS2 Fixed 2.5 (3/32)	3-5 (1/8-3/16)

These stitches are used to join two pieces of fabric while leaving a space between their edges.





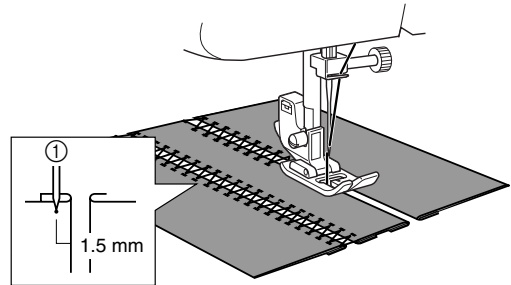

- 1 Fold over the edges of the two pieces of fabric for the hem and baste the edges to a thin piece of paper leaving a small space between them.

- 2 Set the pattern selection dial to the Smocking Stitch, Fagoting Stitch, or Decorative Stitch.
- 3 Stitch along the edge, pulling both threads slightly when beginning to sew. Use thicker than normal threads for sewing.
- 4 After sewing, remove the basting and the paper. Finish by tying knots on the reverse side at the beginning and the end of the seams.



① First needle drop

Overedge Stitching

Stitch Name	Pattern	Stitch Length [mm (inch)]	Stitch Width [mm (inch)]
Elastic Shell Tuck Stitch		F-3 (1/64-1/8)	3-5 (1/8-3/16)
Stretch Overlock Stitch		SS1 Fixed 2.5 (3/32)	3-5 (1/8-3/16)
		SS Fixed 2.5 (3/32)	
Elastic Overlock Stitch		SS1 Fixed 2.5 (3/32)	3-5 (1/8-3/16)
		SS Fixed 2.5 (3/32)	
Arrowhead Stitch		SS1 Fixed 2.5 (3/32)	3-5 (1/8-3/16)
		SS Fixed 2.5 (3/32)	
Arrowhead Stitch		SS1 Fixed 2.5 (3/32)	3-5 (1/8-3/16)
		SS Fixed 2.5 (3/32)	
Comb Stitch		SS2 Fixed 2.5 (3/32)	3-5 (1/8-3/16)
Comb Stitch		SS2 Fixed 2.5 (3/32)	3-5 (1/8-3/16)

You can use these stitches to join together seams and finish them in one operation. The Overlock Stitches are also useful for sewing stretch materials while the Arrowhead Stitch is ideal for sewing the edge of a blanket.

- 1** Set the pattern selection dial to an overedge stitch.
- 2** Put the fabric under the presser foot so that the seamline (or arrowhead point) is approximately 3 mm (1/8 inch) to the left of the center of the presser foot. This stitch works best with a seam allowance of approximately 5 mm (3/16 inch) as this allows the right (zigzag) side of the stitch to overlock the cut edge of the fabric.

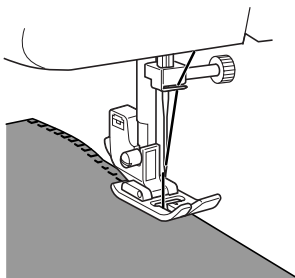

- 3** If the seam allowance is wider than the stitch pattern, trim away any excess fabric after stitching.

A finished Elastic Overlock Stitch is shown in the illustration below.

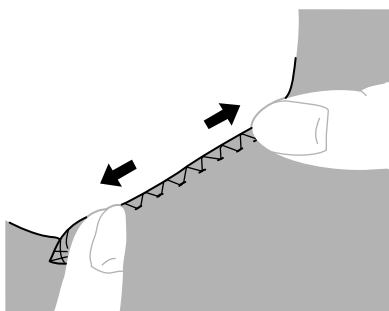

Feather Stitching

Stitch Name	Pattern	Stitch Length [mm (inch)]	Stitch Width [mm (inch)]
Feather Stitch	18 V V V	SS1 Fixed 2.5 (3/32)	3-5 (1/8-3/16)
		SS Fixed 2.5 (3/32)	

Use the Feather Stitch as a decorative top stitch when embroidering or when hemming blankets, tablecloths, or draperies.

- 1** Set the pattern selection dial to the Feather Stitch.
- 2** Place the fabric right side up and sew 1 cm (3/8 inch) from the edge of the fabric.
- 3** Trim close to the stitching. The stitch will prevent the fabric from unravelling.

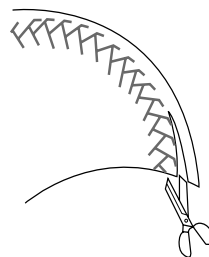







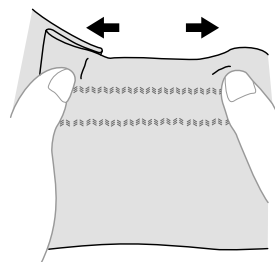



Triple Zigzag Stretch Stitching

Stitch Name	Pattern	Stitch Length [mm (inch)]	Stitch Width [mm (inch)]
Triple Zigzag Stretch Stitch	15 Z	SS1 Fixed 2.5 (3/32)	3-5 (1/8-3/16)
		SS Fixed 2.5 (3/32)	

This stitch can be used wherever a zigzag stitch would be used to sew heavyweight stretch fabrics. The Triple Zigzag Stretch Stitch can also be used as a decorative top stitch. Set the pattern selection dial to the Triple Zigzag Stretch Stitch.



Decorative Stitching

Stitch Name	Pattern	Stitch Length [mm (inch)]	Stitch Width [mm (inch)]
Triangle Stitch	13 	F-1.5 (1/64-1/16)	3-5 (1/8-3/16)
Decorative Stitch	21 	SS1 Fixed 2.5 (3/32)	3-5 (1/8-3/16)
		SS Fixed 2.5 (3/32)	
Leaf Stitch	22 	SS1 Fixed 2.5 (3/32)	3-5 (1/8-3/16)
		SS Fixed 2.5 (3/32)	
Tree Stitch	23 	SS1 Fixed 2.5 (3/32)	3-5 (1/8-3/16)
		SS Fixed 2.5 (3/32)	
Legs Stitch	24 	SS1 Fixed 2.5 (3/32)	3-5 (1/8-3/16)
		SS Fixed 2.5 (3/32)	
Decorative Stitch	25 	SS1 Fixed 2.5 (3/32)	3-5 (1/8-3/16)
		SS Fixed 2.5 (3/32)	
Stretch Overlock Stitch	26 	SS2 Fixed 2.5 (3/32)	3-5 (1/8-13/64)
Stretch Overlock Stitch	27 	SS2 Fixed 2.5 (3/32)	3-5 (1/8-13/64)
Decorative Stitch	31 	SS2 Fixed 2.5 (3/32)	3-5 (1/8-3/16)
Decorative Hem Stitch	34 	SS2 Fixed 2.5 (3/32)	3-5 (1/8-3/16)
Decorative Stitch	35 	SS2 Fixed 2.5 (3/32)	3-5 (1/8-3/16)

These stitches can be used for decorative top stitching and for smocking. Set the pattern selection dial to the Triangle Stitch, Leaf Stitch, etc.

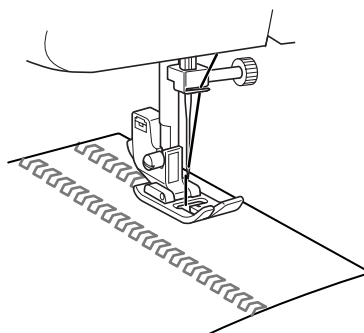
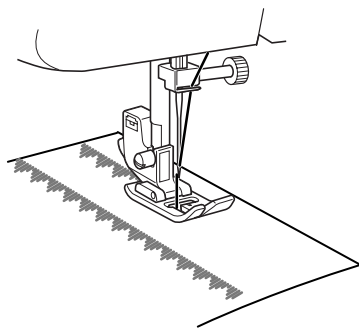

4 SEWING BUTTONHOLES AND BUTTONS

Making a Buttonhole (1-Step Automatic Buttonhole)

Pattern	Stitch Length [mm (inch)]	Stitch Width [mm (inch)]	Foot
1 	F-1.5 (1/64-1/16)	3-5 (1/8-3/16)	Buttonhole Foot



Memo

- We recommend that you practice making a buttonhole on a scrap piece of fabric before you try it on an actual garment.
- When making buttonholes on soft fabrics, place a stabilizer material on the underside of the fabric.

Making a buttonhole is a simple process that provides reliable results.

■ Making a Buttonhole

- 1 Using tailor's chalk, mark the position and length of the buttonhole on the fabric.

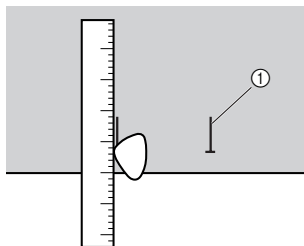

① Marks on fabric

- 2 Attach the buttonhole foot and set the pattern selection dial to "F".
- 3 You need to sew the front bar tack first. Lower the presser foot to align the marks on the foot with the mark on the fabric.

- 4 Open the button plate and insert the button.

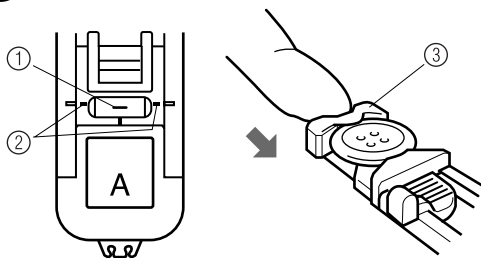

- ① Starting mark on the fabric
- ② Marks on the foot
- ③ Button plate

- 5 Lower the buttonhole lever and push it back slightly.

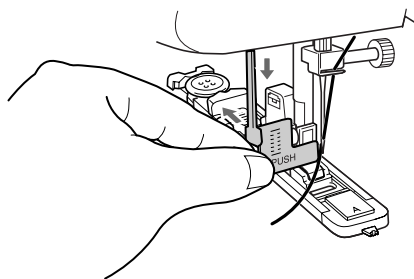

- 6 While gently holding the upper thread, start the machine.
- 7 The bar tacks of the buttonhole are sewn in the order shown.

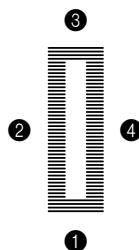

- 8 Stop the machine when buttonhole stitching is finished.

■ Making a Buttonhole on Stretch Fabrics

When sewing buttonholes on stretch fabric, the buttonhole stitching is sewn over a gimp thread.

- 1 Using tailor's chalk, mark the position of the buttonhole on the fabric, and then attach the buttonhole foot and set the pattern selection dial to "F".

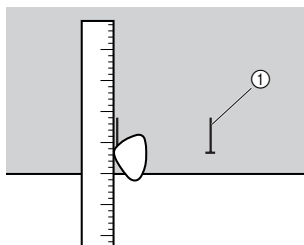

① Marks on fabric

- 2 Hook the gimp thread onto the back end of the buttonhole foot, bring the two gimp thread ends to the front of the foot, insert them into the grooves, and then temporarily tie them there.
- 3 Set the stitch width to match the diameter of the gimp thread.
- 4 Lower the presser foot and start sewing.
- 5 Once sewing is completed, gently pull the gimp thread to remove any slack, and then trim off the excess.

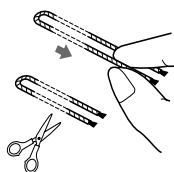
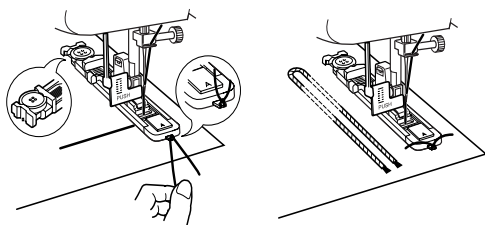

Adjusting Buttonholes

If the stitching on the two sides of the buttonhole is not the same, you can make the following adjustments.

- 1 Set the stitch length dial between "F" and 1.5 and sew the buttonhole on a scrap piece of fabric to observe how the material is fed.
- 2 If the right side of the buttonhole is too open or tight, adjust the feeding of the material with the stitch length dial.

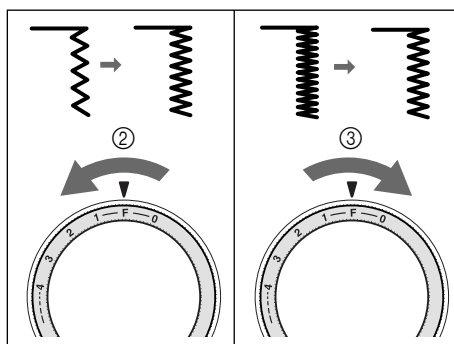

- ① Right side
- ② Shorter
- ③ Longer

- 3 After obtaining a satisfactory feed on the right side, stitch the buttonhole and observe the feeding.

- 4** If the left side is too open or tight compared with the right side, adjust the buttonhole fine-adjustment screw as described below.

If the left side is too open, turn the buttonhole fine-adjustment screw with a large screwdriver in the – direction.

If the left side is too tight, turn the buttonhole fine-adjustment screw with a large screwdriver in the + direction.

- This adjustment ensures both sides of the buttonhole are the same.

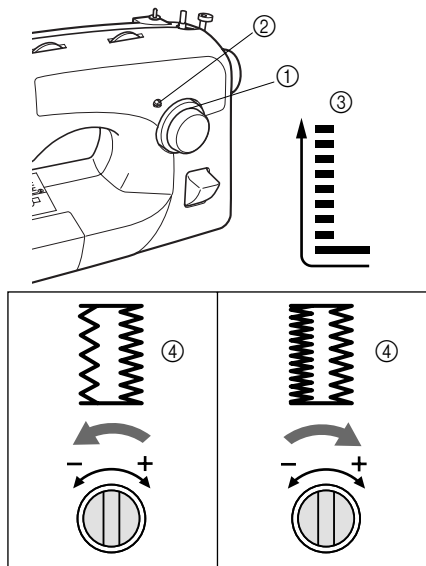

- ① Stitch length dial
- ② Buttonhole fine-adjustment screw
- ③ Left side
- ④ Buttonhole appearance

Sewing Buttons

Stitch Name	Pattern	Stitch Length [mm (inch)]	Stitch Width [mm (inch)]	Foot	Other
Zigzag Stitch		F (1/64)	Any	Button Sewing Foot	Darning Plate

- 1** Measure the distance between the buttonholes and mark the fabric. Then set the pattern selection dial to the Zigzag Stitch, and set the width you want.
- 2** Turn off the machine.
- 3** Change the foot to the button sewing foot.

- 4** Place the darning plate on the needle plate.

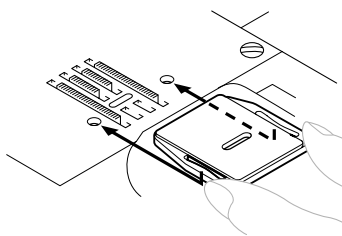

- 5** Turn on the machine.

- 6** Put a button between the foot and the fabric and make sure that the needle enters the holes without hitting the button. If it hits, see step 1.

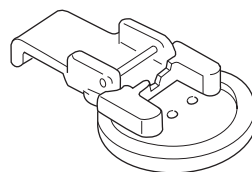

- 7** At a slow speed, sew about 10 stitches.

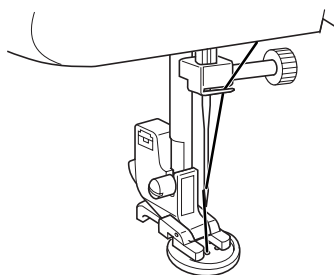

- 8** Remove the material from the machine. Cut the upper and lower threads and tie both threads at the back of the material.



CAUTION

- Make sure the needle does not hit the button during sewing. The needle may break and you may be injured.

Zipper Insertion

Stitch Name	Pattern	Stitch Length [mm (inch)]	Stitch Width [mm (inch)]	Foot
Straight Stitch	2 -	2-3 (1/16-1/8)	2.5 (center) (3/32)	Zipper Foot

You can use the zipper foot to sew different types of zippers, and can easily position it to the right or left side of the needle.

When sewing the right side of the zipper, attach the shank to the left pin of the zipper foot. When sewing the left side of the zipper, attach the shank to the right pin of the zipper foot.

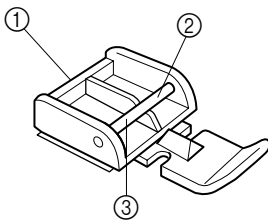

- ① Zipper foot
- ② Right pin for sewing the left side of the zipper
- ③ Left pin for sewing the right side of the zipper

- 1** Turn off the machine and raise the presser foot.
- 2** Set the pattern selection dial to the Straight Stitch. Set the stitch length between 2 (1/16 inch) and 3 (1/8 inch). Set the stitch width at 2.5 (3/32 inch) to move the needle into the correct position.
- 3** To attach the zipper foot, lower the presser foot lever either on the left or right pin of the zipper foot.

- 4** Fold the edge of the material 2 cm (3/4 inch) and place the zipper under the folded section. Lower the needle into the notch located either on the left or right side of the zipper foot.

CAUTION

- Turn the handwheel by hand to make sure the needle does not hit the zipper foot before you start sewing. Choosing a different stitch will cause the needle to hit the presser foot and break, and you may be injured.

- 5** Sew from the bottom of the zipper toward the top on both sides. The needle should be positioned on the zipper side of the foot for best results.

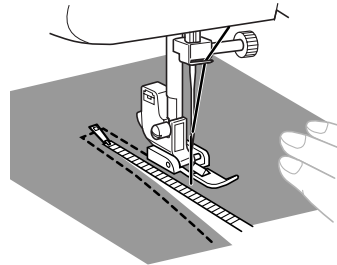

- 6** To sew the opposite side of the zipper, first turn the machine off and raise the presser foot lever. Release the zipper foot by pressing the button located at the back of the foot, then fit the foot on the other side of the zipper. Continue sewing using the pin on that side of the zipper foot.

CAUTION

- Make sure the needle does not hit the zipper during sewing. If the needle hits the zipper, the needle may break and you may be injured.

Gathering

Stitch Name	Pattern	Stitch Length [mm (inch)]
Straight Stitch	2 	4 (3/16)

- 1 Set the pattern selection dial to Straight Stitch.
- 2 Loosen the tension of the upper thread so that the lower thread lies on the underside of the material.
- 3 Sew a single row (or many rows) of straight stitches.
- 4 Pull the lower threads to gather the material.

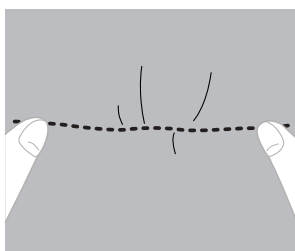

Darning

Stitch Name	Pattern	Stitch Length [mm (inch)]	Foot	Other
Straight Stitch	2 	Any	Zigzag Presser Foot	Darning Plate

- 1 Turn off the machine. Place the darning plate on the needle plate, then turn on the machine.

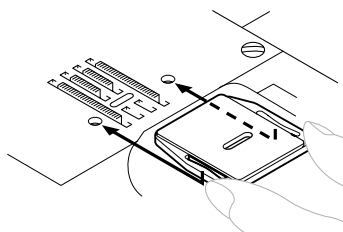

- 2 Set the pattern selection dial to the Straight Stitch.
- 3 Put the section you want to darn under the presser foot together with fabric for reinforcement.
- 4 Lower the presser foot.
- 5 Begin sewing by alternating between gently drawing the work away from you and pulling it toward you.
- 6 Repeat this motion until the darn section is filled with parallel lines of stitching.

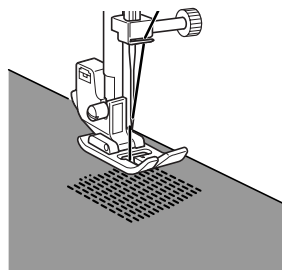

Appliqués

Stitch Name	Pattern	Stitch Length [mm (inch)]	Stitch Width [mm (inch)]
Zigzag Stitch		F-2 (1/64-1/16)	Any

You can create an applique by cutting a different piece of fabric into a shape and using it as a decoration.

- 1 Baste the cut design to the fabric.
- 2 Carefully sew around the edge of the design with a zigzag stitch.

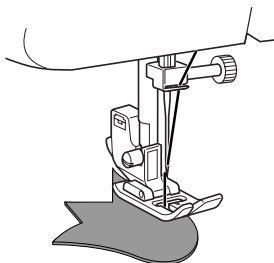

- 3 Cut away any fabric that is left outside the stitching.

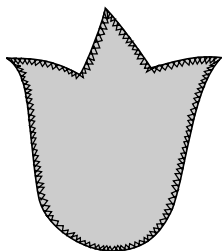

- 4 Remove the basting, if necessary.



Memo

- Make reinforcing straight stitches at the beginning and the end of the zigzag stitching.

CAUTION

- Be careful that the needle does not hit a pin during sewing. The needle could break, and you may be injured.

Monogramming and Embroidering

Stitch Name	Pattern	Stitch Length [mm (inch)]	Stitch Width [mm (inch)]	Foot	Other
Zigzag Stitch		Any	Any	None	Darning Plate

■ Preparing for Monogramming and Embroidering

- 1 Turn off the machine.
Place the darning plate on the needle plate, then turn on the machine.

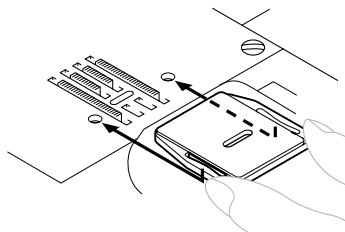

- 2 Set the pattern selection dial to Zigzag Stitch.
- 3 Draw the lettering (for monogramming) or design (for embroidering) on the surface of the fabric.
- 4 Stretch the fabric between embroidery hoops as firmly as possible, with the underside of the fabric on the bottom of the inside hoop.
- 5 Put the work under the needle and lower the presser bar with the foot removed.
- 6 Pull the lower thread up through the starting position by turning the handwheel and make a few holding stitches.

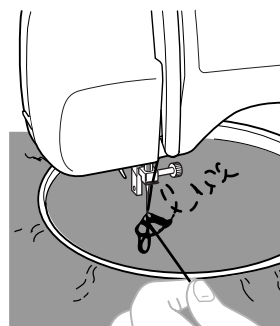

- 7 Grip the hoop with your thumbs and forefingers while pressing the fabric with your middle and third fingers and supporting the outside of the hoop with your little fingers.

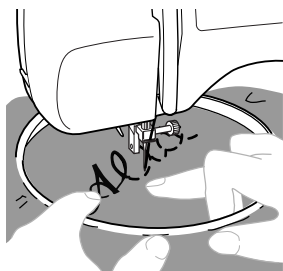

CAUTION

- Keep fingers away from moving parts, especially needles.

■ Monogramming

- 1 Sew by moving the hoop slowly along the lettering at a constant speed.
- 2 Secure with a few straight stitches at the end of the last letter.

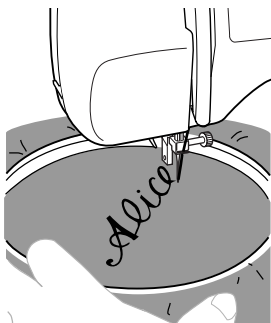

CAUTION

- Keep fingers away from moving parts, especially needles.

■ Embroidering

- 1 Stitch the outline of the design by moving the embroidery hoop.

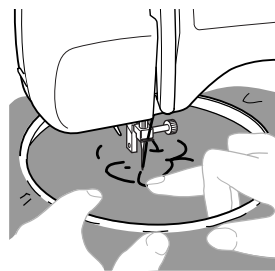

- 2 Fill in the design alternating from the outline of the design to the inside and from the inside to the edge of the outline until the design is completely filled in. Keep the stitching close together.

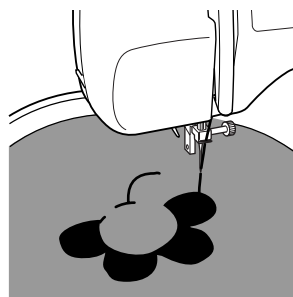

Memo

- You can make long stitches by moving the embroidery hoop rapidly and short stitches by moving it slowly.

- 3 Secure with a few straight stitches at the end of the design.

CAUTION

- Keep fingers away from moving parts, especially needles.

OPTIONAL ACCESSORIES

Using the Walking Foot

Stitch Name	Pattern	Stitch Length [mm (inch)]	Stitch Width [mm (inch)]
Straight Stitch	2 	1-4 (1/16-3/16)	2-3 (1/16-1/8)
Zigzag Stitch	3 /	1-4 (1/16-3/16)	0-5 (0-3/16)

This foot is very useful for sewing materials such as vinyl cloth, synthetic leather, thin leather, etc. These materials are difficult to feed when sewing. The walking foot prevents these materials from crumpling, slipping or sticking between the presser foot and the material.



Note

- Only use the walking foot with straight or zigzag stitches. Do not use other patterns. Reverse stitches can not be sewn with the walking foot.

- 1 Turn off the machine.
- 2 Raise the needle and the presser foot.
- 3 Loosen the presser foot screw to remove the presser foot holder.

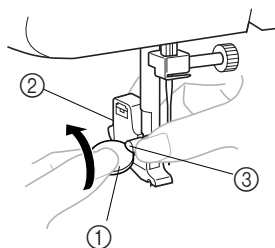

- 1 Use a coin or screwdriver
- 2 Presser foot holder
- 3 Presser foot screw

- 4 Attach the forked section of the connecting lever to the needle clamp, and fit the walking foot to the presser bar.

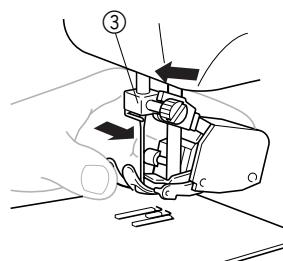
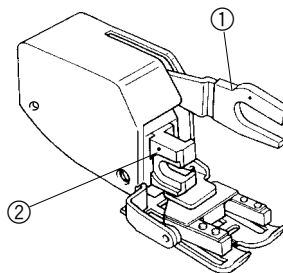

- 1 Forked part of operation lever
- 2 Presser bar holder
- 3 Needle clamp

- 5 Lower the presser foot lever and then tighten the presser foot screw.

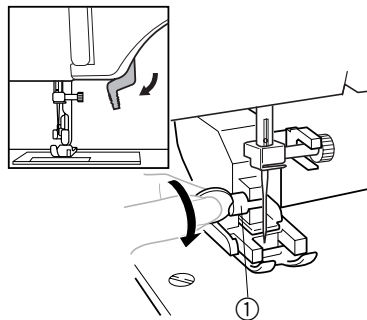

- 1 Presser foot screw

CAUTION

- Use a coin or screwdriver to tighten the screw securely. If the screw is loose, the needle may hit the presser foot and you may be injured.
- Before you start sewing, make sure you turn the handwheel toward you (counterclockwise) to check that the needle does not hit the presser foot.
- Be careful not to touch the needle, otherwise you may be injured.



Note

- When sewing with the walking foot, sew at medium to low speeds.

Using the Quilting Foot

Stitch Name	Pattern	Stitch Length [mm (inch)]	Stitch Width [mm (inch)]	Other
Straight Stitch	2 	Any	2.5 (3/32)	Darning Plate

The Quilting Foot is useful for darning and free-motion machine quilting.

- 1 Turn off the machine.
- 2 Raise the needle and the presser foot.
- 3 Loosen the presser foot screw to remove the presser foot holder.

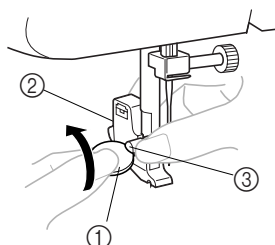

- 1 Use a coin or screwdriver
- 2 Presser foot holder
- 3 Presser foot screw

- 4 Attach the quilting foot, making sure that part A shown in the illustration is above the needle clamp screw. Then lower the presser foot lever and tighten the presser foot screw.
 - Make sure that the needle clamp screw is firmly tightened.

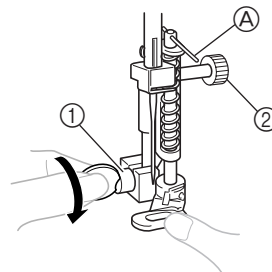

- 1 Presser foot screw
- 2 Needle clamp screw

CAUTION

- Be careful not to touch the needle, otherwise you may be injured.
- Use a coin or screwdriver to tighten the presser foot holder screw securely. If the screw is loose, the needle may hit the presser foot and you may be injured.
- Before you start sewing, make sure you turn the handwheel toward you (counterclockwise) to check that the needle does not hit the presser foot.

- 5 Put the darning plate on the needle plate. Turn on the machine.

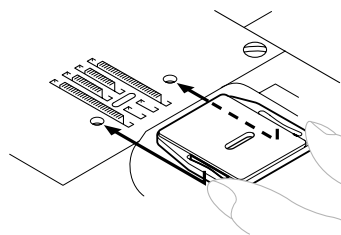

- 6 Set the pattern selection dial to the Straight Stitch.
 - Before starting to sew, draw the quilting design on the fabric.

- 7** Use both hands to keep the fabric firmly stretched and move the fabric to sew over the drawn design.

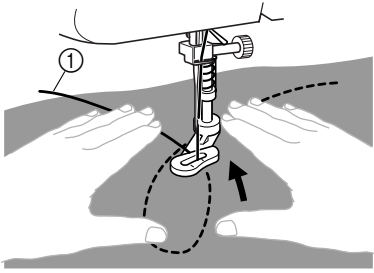

① Quilting design

- 8** The length of the stitch depends on how quickly you move the fabric and on the machine's sewing speed. Sew while moving the fabric slowly.

Using the 1/4-inch Quilting Foot

Stitch Name	Pattern	Stitch Length [mm (inch)]	Stitch Width [mm (inch)]
Straight Stitch	2 	2-2.5 (1/16-3/32)	2.5 (center) (3/32)

You can use the 1/4-inch Quilting Foot to sew seams when piecing together a quilt.

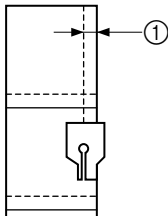
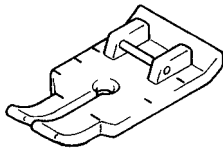

① Seam allowance 6.5 mm (1/4 inch)

- 1** Turn off the machine.
- 2** Set the pattern selection dial to the Straight Stitch. Set the stitch length between 2 (1/16 inch) and 2.5 (3/32 inch). Set the stitch width at 2.5 (3/32 inch) (center).

- 3** Attach the 1/4-inch Quilting Foot. Turn on the machine.

- 4** Position the presser foot over the fabric and sew as shown in the illustration below.

■ Achieving an Accurate Seam Allowance

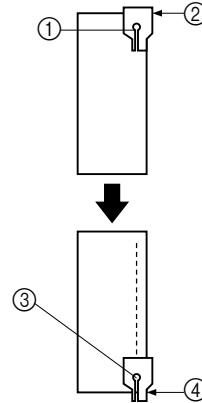

- ① Beginning of stitching
 ② Align this mark with the edge of the fabric.
 ③ End of stitching
 ④ Align this mark with the edge of the fabric.

■ Stitching the Top of a Quilt

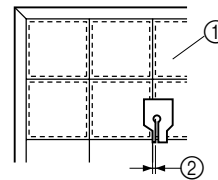

- ① Top of fabric
 ② Seam 3.2 mm (1/8 inch)

6 **APPENDIX****MAINTENANCE****Changing the Light Bulb****CAUTION**

- Turn off the main power switch and unplug the machine before you change the light bulb. If the main power switch is on when you change the light bulb, you may get an electric shock. If the machine is on and you step on the foot controller, you may be injured.
- To avoid burns, let the light bulb cool down before you change it.

- 1 Remove the power supply plug from the outlet.
- 2 Loosen the screw on the back of the sewing head. Then remove the light cover from the machine.

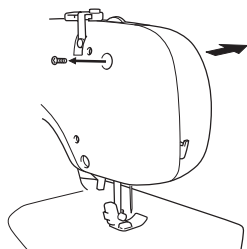

- 3 Replace the sewing light bulb.

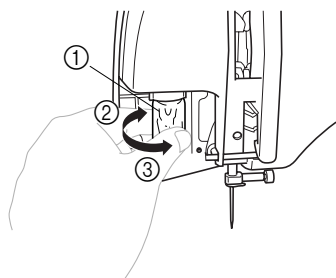

- 1 Bulb
- 2 Loosen
- 3 Tighten

- 4 Put the light cover back on and fasten the screw.

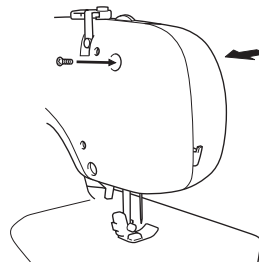
**Cleaning****CAUTION**

- Make sure you unplug the machine before you clean it, otherwise you risk getting an electric shock or being injured.

- 1 Switch the machine off and unplug it.
- 2 Raise the needle and the presser foot.
- 3 Loosen the presser foot screw and the needle clamp screw to remove the presser foot holder and the needle.

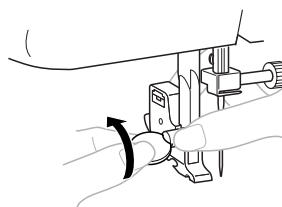

- 4 Grasp both sides of the needle plate cover, and then slide it toward you to remove the needle plate cover.

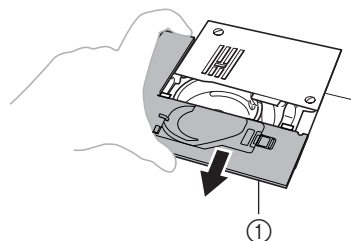

- 1 Needle plate cover

- 5** Using a coin, remove the two screws. Lift up the needle plate as shown in the illustration, and then slide the needle plate to the left to remove it.

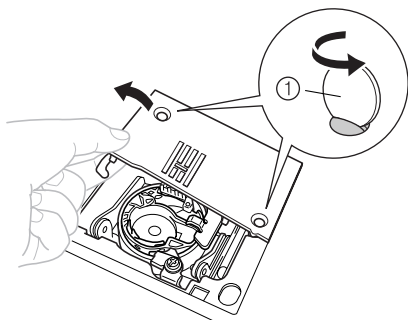

① Use a coin or screwdriver

- 6** Grasp the bobbin case, and then lift it out to the left.

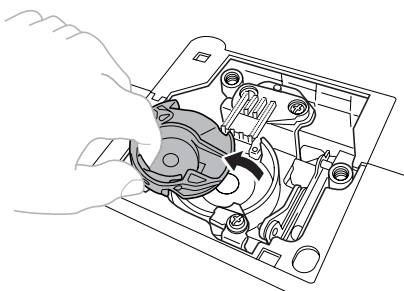

- 7** Use the cleaning brush or a vacuum cleaner to remove any dust from the race and its surrounding area.

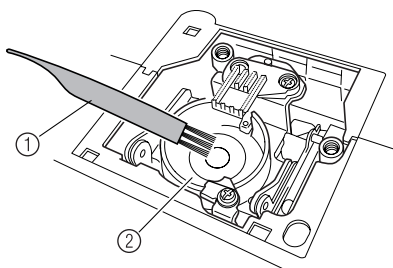

① Cleaning brush
② Race

- Do not apply oil to the bobbin case.

- 8** Insert the bobbin case so that the projection on the bobbin case aligns with the spring.

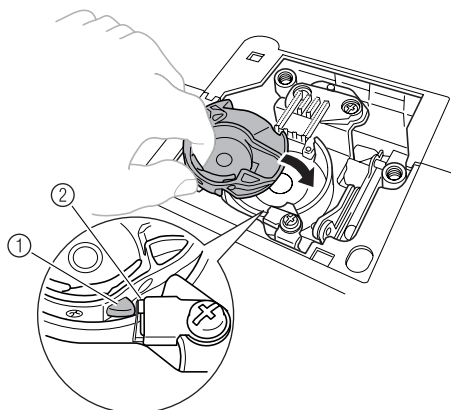

① Projection
② Spring

- 9** Install the needle plate, sliding it to the right to secure it, and then tighten the screws. Make sure that the tab on the left side of the needle plate is aligned with the notch in the bobbin case.

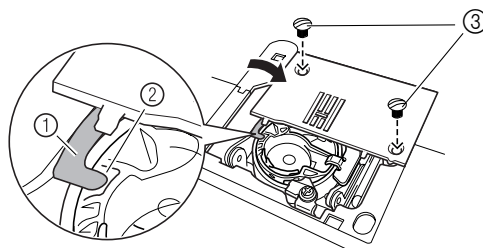

① Tab
② Notch
③ Screws

- 10** Install the needle plate cover. Insert the tabs on the needle plate cover into the notches in the needle plate, and then slide the cover back into position.

⚠ CAUTION

- Never use a bobbin case that is scratched; otherwise the upper thread may become tangled, the needle may break, or sewing performance may suffer. For a new bobbin case (part code: XC8993-021), contact your nearest authorized service center.
- Make sure that you fit the bobbin case properly, otherwise the needle may break.

Troubleshooting

If the machine stops working properly, check the following possible problems.

If the problem is still there, contact your retailer or the nearest authorized service center.

Symptom	Possible cause	How to put it right	Reference
The sewing machine does not work.	The machine is not plugged in.	Plug the machine in.	page 7
	The main power switch is turned off.	Turn on the main power switch.	page 8
	The bobbin-winder shaft is pushed to the right.	Move the bobbin-winder shaft to the left.	page 17
	You have not used the foot controller properly.	Use the foot controller properly.	page 8
The needle breaks.	The needle is not fitted properly.	Fit the needle properly.	page 8
	The needle clamp screw is loose.	Use a coin or screwdriver to firmly tighten the screw.	page 9
	The needle is bent or blunt.	Replace the needle.	page 8
	You have not used the right combination of fabric, thread and needle.	Choose a thread and needle that are appropriate for the type of fabric.	page 26
	The presser foot you are using is not appropriate for the type of stitch that you want to sew.	Attach the presser foot that is correct for the type of stitch that you want to sew.	–
	The upper thread tension is too tight.	Loosen the upper thread tension.	page 25
	You are pulling the fabric too much.	Lightly guide the fabric.	–
	You have not fitted the spool properly.	Fit the spool properly.	page 21, 25
	The area around the hole in the needle plate is scratched.	Replace the needle plate. Contact your retailer or the nearest authorized service center.	–
	The area around the hole in the presser foot is scratched.	Replace the presser foot. Contact your retailer or the nearest authorized service center.	–
	The bobbin case is scratched.	Replace the bobbin case. Contact your retailer or the nearest authorized service center.	–
The upper thread breaks.	You have not threaded the upper thread properly. (For example, you have not fitted the spool properly, or the thread has come out of the guide above the needle.)	Correct the upper threading.	page 21
	There are knots or tangles in the thread.	Remove any knots or tangles.	–
	The needle is not appropriate for the thread you are using.	Choose a needle that is appropriate for the type of stitch.	page 26
	The upper-thread tension is too tight.	Loosen the upper thread tension.	page 25
	The thread is tangled.	Remove the tangled thread. If the thread is tangled in the bobbin case, clean the bobbin case.	page 44
	The needle is bent or blunt.	Replace the needle.	page 8
	You have not inserted the needle properly.	Insert the needle properly.	page 9

Symptom	Possible cause	How to put it right	Reference
The upper thread breaks.	The area around the hole in the needle plate is scratched.	Replace the needle plate. Contact your retailer or the nearest authorized service center.	–
	The area around the hole in the presser foot is scratched.	Replace the presser foot. Contact your retailer or the nearest authorized service center.	–
	The bobbin case is scratched, or has a burr on it.	Replace the bobbin case. Contact your retailer or the nearest authorized service center.	–
	You have not used a bobbin that has been designed for this machine.	Incorrect bobbins will not work properly. Only use a bobbin that has been designed for this machine.	page 16
The lower thread is tangled or breaks.	You have not wound the bobbin thread properly.	Wind the bobbin properly.	page 16
	The bobbin is scratched or does not turn smoothly.	Replace the bobbin.	–
	The thread is tangled.	Remove the tangled thread and clean the bobbin case.	page 44
	You have not used a bobbin that has been designed for this machine.	Incorrect bobbins will not work properly. Only use a bobbin that has been designed for this machine.	page 16
	Bobbin is set incorrectly.	Reset the bobbin thread correctly.	page 18-20
The thread tension is incorrect.	You have not threaded the upper thread properly.	Correct the upper threading.	page 21
	You have not wound the bobbin thread properly.	Wind the bobbin thread properly.	page 16
	You have not threaded the right combination of thread and needle for the fabric you are using.	Choose a thread and needle that are appropriate for the type of fabric.	page 26
	You have not attached the presser foot holder properly.	Attach the presser foot holder properly.	–
	The thread tension is incorrect.	Adjust the tension of the upper thread.	page 25
	You have not used a bobbin that has been designed for this machine.	Incorrect bobbins will not work properly. Only use a bobbin that has been designed for this machine.	page 16
	Bobbin is set incorrectly.	Reset the bobbin thread correctly.	page 18-20
The fabric is wrinkled.	You have not threaded the upper thread properly or fitted the bobbin properly.	Thread the upper thread and wind the bobbin thread properly.	page 18-22
	You have not fitted the spool properly.	Fit the spool properly.	page 21, 25
	You have not used the right combination of fabric, thread and needle.	Choose a thread and needle that are appropriate for the type of fabric.	page 26
	The needle is bent or blunt.	Replace the needle.	page 8
	If you are sewing thin fabric, the stitch is too thick.	Sew with stabiliser material under the fabric.	–
	The thread tension is incorrect.	Adjust the tension of the upper thread.	page 25

Symptom	Possible cause	How to put it right	Reference
Stitches are skipped.	You have not threaded the upper thread properly.	Correct the upper threading.	page 21
	You have not used the right combination of fabric, thread and needle.	Choose a thread and needle that are appropriate for the type of fabric.	page 26
	The needle is bent or blunt.	Replace the needle.	page 8
	You have not inserted the needle properly.	Insert the needle properly.	page 8
	Dust has accumulated under the needle plate or in the bobbin case.	Remove the needle plate cover and clean the plate and the bobbin case.	page 44
There is a high-pitched noise while sewing.	Dust has built up in the feed dogs or in the bobbin case.	Clean the bobbin case.	page 44
	You have not threaded the upper thread properly.	Correct the upper threading.	page 21
	The bobbin case is scratched.	Replace the bobbin case. Contact your retailer or the nearest authorized service center.	–
	You have not used a bobbin that has been designed for this machine.	Incorrect bobbins will not work properly. Only use a bobbin that has been designed for this machine.	page 16
The needle threader can not be used.	You have not moved the needle holder to its highest position.	Turn the handwheel toward you (counterclockwise) to raise the needle holder to the highest position.	page 22
	You have not inserted the needle properly.	Insert the needle properly.	page 9
The stitch is not sewn correctly.	The presser foot that you are using is not correct for the type of stitch.	Attach the presser foot that is correct for the type of stitch that you want to sew.	–
	The thread tension is incorrect.	Adjust the tension of the upper thread.	page 25
	The thread is tangled.	Remove the tangled thread. If the thread is tangled in the bobbin case, clean the bobbin case.	page 44
The fabric does not feed.	The stitch is too fine.	Lengthen the stitch length.	–
	The darning plate is fitted on the needle plate.	Remove the darning plate.	–
	You have not used the right combination of fabric, thread and needle.	Choose a thread and needle that are appropriate for the type of fabric.	page 26
	The thread is tangled.	Remove the tangled thread. If the thread is tangled in the bobbin case, clean the bobbin case.	page 44
The sewing light bulb does not come on.	The sewing light bulb is damaged.	Replace the sewing light bulb.	page 44

INDEX

Numerics

- 1/4-inch quilting foot 43
- 1-Step Automatic Buttonhole 5, 34

A

- Accessories 6
 - optional 6, 41
- Appliqués 39

B

- Blind hem stitching 29
- Bobbin
 - winding 16
- Buttonhole
 - adjusting 35
 - making 34
- Buttonhole fine-adjustment screw 36
- Buttons
 - sewing 36

C

- Cleaning 44
- Connecting plugs 7

D

- Darning 38
- Darning plate 36, 38, 39, 42
- Decorative stitching 33
- Double action stitching 31
- Drawing up the lower thread 24

E

- Elastic stitching 30
- Embroidering 39

F

- Fabric, thread, and needle combinations 26
- Feather stitching 32
- Flat bed attachment 10
- Foot controller 8
- Free-arm style 10

G

- Gathering 38

H

- Handwheel 21
- Heirloom stitching 31

L

- Light bulb
 - changing 44
- Light switch 8
- Lower threading 18
 - quick-set bobbin 19, 24

M

- Main parts 5
- Main power 8
- Maintenance 44
- Monogramming 39

N

- Needle
 - checking 8
 - combinations with fabric and thread 26
 - replacing 8
- Needle threader 22

O

- Overedge stitching 31

P

- Pattern selection dial 11
- Patterns 12
- Presser foot
 - changing 9

Q

- Quick-set bobbin 19, 24
- Quilting foot 42

R

- Race
 - cleaning 44
- Repacking instructions 2
- Reverse sewing lever 15

S

- Satin stitch 28
- Shell tuck stitching 29
- Spool pin 16, 21
 - extra 25
- Stitch length dial 14
- Stitch width dial 15
- Stitches
 - built-in 29
 - names 12
- Straight stitching 27
- Stretch stitching 15

T

- Thread cutter 28
- Thread tension 25
- Threading
 - lower 18, 19
 - needle threader 22
 - twin needle 25
 - upper 21
- Triple zigzag stretch stitching 32
- Troubleshooting 46
- Twin needle
 - attaching 9, 25
 - sewing 24

U

- Unpacking instructions 2
- Upper tension control dial 25
- Upper threading 21

W

- Walking foot 41

Z

- Zigzag stitching 28
- Zipper insertion 37

